



EXPLOSION PROTECTION

We protect the health and lives of your employees.
Reduce the risk of irrecoverable damages and losses in production.

Fire and explosion protection



Fire and explosion protection

CONTENTS

CUSTOMER SERVICES	3
SYSTEM FOR EXPLOSION SUPPRESSION	
■ HRD SYSTEM	4-5
EXPLOSION VENTING	
■ EXPLOSION VENTING DEVICES	6-9
■ FLEX FLAMELESS VENTING	10-12
EXPLOSION ISOLATION SYSTEM	
■ BACK PRESSURE FLAP B-FLAP I	13-14
■ HRD BARRIER	15
■ QUICK-ACTING SLIDE VALVE GATEX	16
■ ANTI-EXPLOSION DIVERTER	17
EXPLOSION PROTECTION OF BUCKET ELEVATORS	
■ ELEVEX	18-19

If there are the following things available at a given location and time:

- **Substances that create explosive atmosphere**
- **Sufficient amount of oxygen or another oxidizing agent**
- **Effective ignition source**

then explosion risk becomes a real threat.

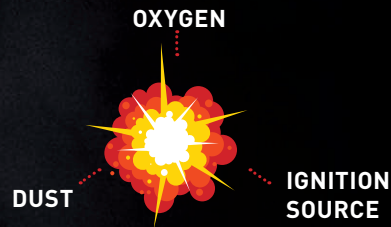

Use of suitable anti-explosion elements can significantly lower negative effects of possible accidents in industrial operations and protect significant financial means, as well as health and lives of service personnel. Proper application follows correct assumptions for design of protection systems and requires complex approach to these questions.

 Proudly made in the Czech Republic

All products and equipment made by the RSBP Company are tested and meet the current legislature requirements. We design and completely solve safety of operations and individual pieces of equipment from the point of view of fire and explosion prevention, risk analysis, engineering and documentation according to the current regulation 99/92/EC – ATEX 137. We provide engineering expertise according to valid safety standards, regulations, ordinances and directives according to ATEX, VDI and NFPA. To get more information, please contact us at www.rsbp.cz or address our experts directly.

We can find your solution.

TURN TO OUR SPECIALISTS

The RSBP Company is ready to offer its services in the area of fire and explosion complex solutions, and thus eliminate fire and explosion consequences. By expert evaluation we can determine the amount of explosion danger risk, just as by proposing of suitable solution we can take care of its elimination or complete exclusion. We will limit risks of damages in your operation.



OUR CUSTOMER CARE REPRESENTS:

AVAILABILITY

We are available on the phone, e-mail or directly in the field – in order for our reaction to be as fast as possible and you had the least amount of worries with our supplies.

SPEED

Everything related with your requirements is solved as quickly as possible. We all take care of your supplies that is why it is easy for us to understand you.

HELPFULNESS

Thanks to our knowledge and experience we can advise you and help you with correct decisions.

WHAT WE OFFER:

PROCESSING OF INPUT REQUIREMENTS – solution of “ATEX” questions

- Creation of fire – technical and explosion characteristics of substances
- Measurements of dust, gas, and vapor concentrations
- Creation of protocol proposals and determination of outside influences
- Measurements of initiation sources
- Determination of risk sources and investigation of practical reasons for explosions

ANALYSIS AND EVALUATION of current status in the “ATEX” area

- Creation of the Explosion protection documents including its updates
- Discussion of Protection against explosion documentation with statutory bodies
- Writing of expertise concerning explosions of flammable dusts
- Checking and delineation of zones in project documentation for current production lines
- Instructions and seminars concerning EX environment for government administration and operators

PROPOSALS OF SOLUTIONS in the “ATEX” area

- Project designs of protection of technological equipment against explosion
- Software simulations of existing technology resistance
- Practical measurements of pressure resistance of industrial equipment (filters, silos...)
- Compete proposals of organizational and technical measures to lower or minimize risks of explosion danger
- Manufacture, installation, and service activities in the area of fire and explosion protection
- We are able to determine the amount of explosion risk by expert evaluation of your technological process, as well as to propose suitable measures for its mitigation or complete elimination, and thus limit the risk of damages to your production

SERVICE

Our fully qualified service department is available on the phone 24 hours a day 7 days a week and it is ready to help you any time with your current needs.

- We offer regular services according to legislature
- We perform repairs and supply spare parts
- We cover complete execution in cases when you expand your production line, etc.
- We service all equipment installed by our company

Turn to our service department and cooperate only with the best experts in the field.



HRD (high rate discharge) system is a well-tried system for explosion suppression. It detects the initial phase of explosion and then suppresses explosions of flammable dusts in industrial technologies. The equipment reaction time counts in milliseconds.

The HRD system will protect filters and filtration units, industrial vacuums, silos, mills, dryers, cyclones, conveyors, dust reservoirs, elevators, mixers, crushers and other industrial equipment against explosion effects.

Thanks to its perfect function the HRD system effectively suppresses explosion, limits explosion pressure inside equipment under its pressure resistance and thus prevents its destruction. It eliminates technological damages, but primarily protects human health.

ADVANTAGES OF THE HRD SYSTEM:

- Well-tried and effective technology
- Fast reaction of the system
- High reliability
- Use in inside and outside areas
- Suitable solution for toxic and other dangerous materials
- Independent archiving of detector data
- Customization according to customer quality wishes
- Variable use of components
- Simple and fast exchange of components after activation
- Easy manipulation and transport
- Extinguishing agent suitable for food industry

DIAGRAM OF HRD SYSTEM INSTALLATION ON A SEPARATOR LOCATED ON A PIPE

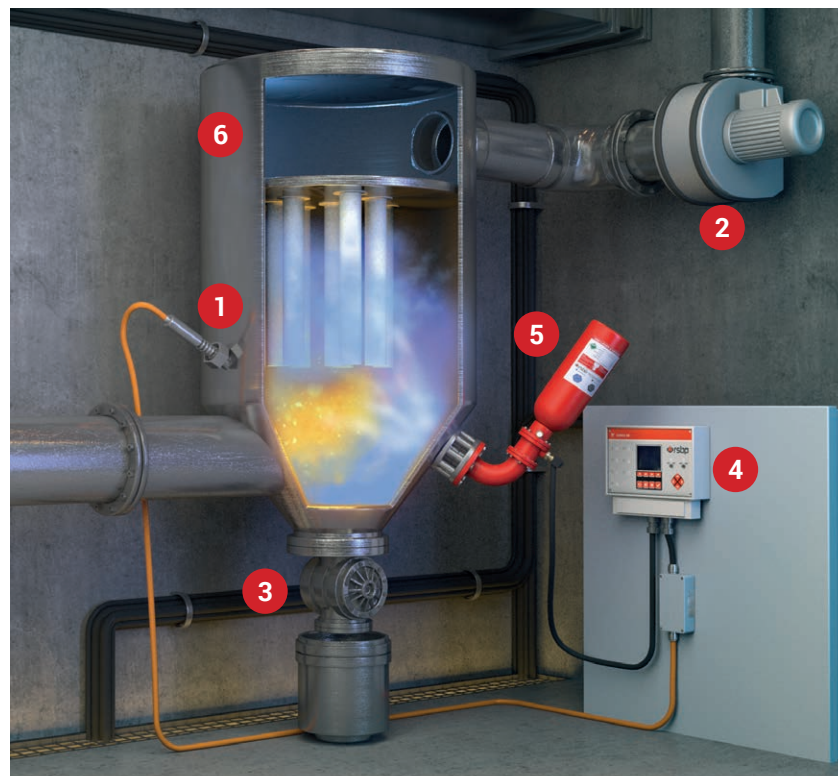

1. Explosion detector
2. Fan
3. Rotary valve
4. Control unit
5. HRD container unit
6. Filter

Highly sensitive detectors can detect the emerging explosion within milliseconds, the system will open HRD valves and activate HRD bottles with extinguishing material. Extinguishing agent pressure will extend special telescopic nozzles that will provide effective spread of the extinguishing agent into the whole protected system. The activation takes place very quickly. The explosion pressure is, thanks to the HRD system, under control and its undesired effects are minimized.



BASIC PARTS OF THE HRD SYSTEM

CONTROL UNIT



Simple or multiple zone control unit evaluates and archives detector information, activates extinguishing bottles, monitors circuits for connection of other devices, provide data to superior systems and serves as a user interface to the operators.

EXPLOSION DETECTOR



Pressure detectors recognize incipient explosion in time. They will pass this information to the control unit extremely quickly. Their advantage is a short reaction time (in milliseconds) and variability of use.

HRD CONTAINER UNIT



Special HRD vessels equipped by fast-opening valves and other accessories contain extinguishing agent under stable pressure. When an explosion is detected, they provide immediate and effective introduction of the extinguishing agent into the protected equipment. Variability of bottle sizes [5, 8, 20 or 50 liters], quick and fast explosion suppression are the advantages. Easy manipulation and simple maintenance are a bonus for the customer.

EXPLOSION SUPPRESSION PROCESS

TIME:	0 ms	5 – 35 ms	40 ms	60 ms
PRESSURE:	0 bar	0,03 – 0,15 bar	0,1 – 0,25 bar	0,2 – 0,4 bar



1. Initiation
2. Detection of explosion origin
3. Extinguishing agents injection
4. Explosion pressure reduction
5. Explosion suppression

Progress of explosion pressure increase related to time

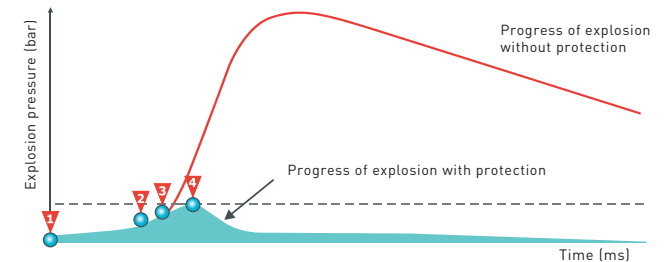

1. Initiation
2. Detection of explosion origin
3. Activation of HRD container unit (extinguishing agents injection, explosion pressure reduction)
4. Explosion suppression

In order to secure complete protection of protected technologies we recommend using the HRD system in combination with a product for preventing explosion propagation – an HRD barrier.



Explosion venting devices are protection devices intended for protection of industrial equipment with explosion danger. RSBP equipment for explosion venting is a perfect solution to lower this risk and eliminate losses that follow such

explosions. RSBP explosion venting devices offer very effective and economical solution of protection against damages resulting from a powder explosion.

These devices are primarily suitable for protection of filters, reservoirs, mills, crushers, cyclones and other equipment with dust explosion danger.

ADVANTAGES:

- High effectivity and reliability
- Long service life
- Resistivity against abrasion, mechanical particle impacts and weather conditions
- Simple installation, exchange and easy availability of spare parts
- Variable safe opening pressure
- Variable panel and auxiliary equipment sizes
- Economically advantageous solution

DIAGRAM OF INSTALLATION OF THE EQUIPMENT ON A DUST SEPARATOR

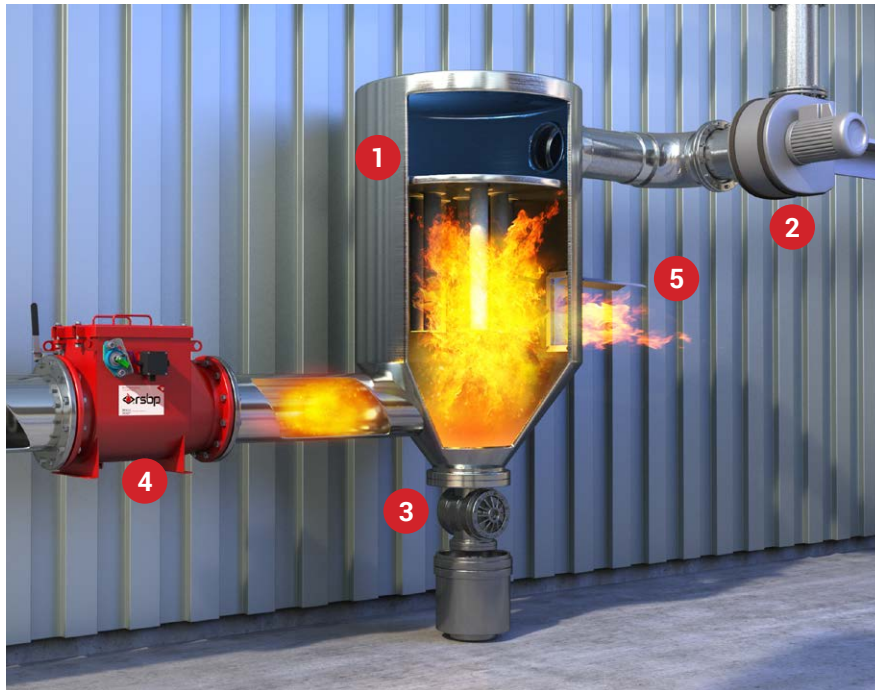

1. Filter
2. Fan
3. Rotary valve
4. Back pressure flap B-FLAP I
5. Explosion venting device

Under normal operating conditions the equipment vent area is covered by an explosion venting devices. If an operational pressure is exceeded inside of the equipment, a venting device on its surface opens and relieves pressure from the endangered area. The technology equipment is thus exposed to smaller pressure than is its pressure resistance, and therefore it will not be destroyed.





VMP – DOMED ROUND EXPLOSION VENTING DEVICES

- Domed triple layer venting devices with PTFE isolation
- For equipment with operational temperature of up to 240 °C
- High underpressure resistance
- Stainless steel
- Suitable also for equipment with pressure pulses
- SU – Domed triple layer venting devices with PTFE isolation
- Certification according to EN 14 797

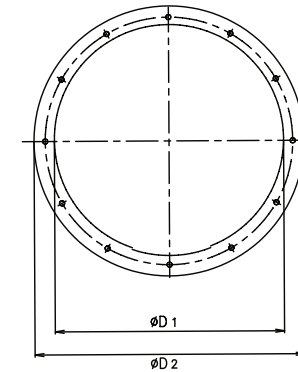

TECHNICAL PARAMETERS:

Type	SU*	Venting area (m ²)	Ø D1 inside flange dimension (mm)	Ø D2 outside flange dimension (mm)
VMP 250	x	0,05	270	350
VMP 300	x	0,06	320	380
VMP 350	x	0,07	345	425
VMP 400	x	0,10	400	480
VMP 450	x	0,13	450	530
VMP 510	x	0,16	510	590
VMP 600	x	0,24	600	680
VMP 630	x	0,27	630	710
VMP 750	x	0,41	770	850
VMP 800	x	0,47	820	900
VMP 880	x	0,53	880	960
VMP 900	x	0,57	900	1000
VMP 1000	x	0,72	1000	1100
VMP 1100	x	0,87	1100	1200

*SU – Domed triple layer venting devices with PTFE isolation



VMP – FLAT RECTANGULAR EXPLOSION VENTING DEVICES

- Suitable for applications with low operational pressure (up to 50 % of safety opening pressure)
- For equipment with operational temperature of up to 100 °C
- Installation without top flange
- Stainless steel
- Economical solution
- F – Flat venting devices
- Certification according to EN 14 797

VMP – DOMED RECTANGULAR EXPLOSION VENTING DEVICES

- Single layer construction for equipment with operational temperature of up to 100 °C
- Triple layer construction with high underpressure resistance and PTFE insulation for operational temperatures of up to 240 °C
- Stainless steel
- Suitable also for equipment with pressure pulses
- SU – Domed triple layer venting devices with PTFE isolation
- D – Domed single layer venting devices
- Certification according to EN 14 797

TECHNICAL PARAMETERS:

Type	Relief area (m ²)			A – outside venting devices dimension (mm)			B – outside venting devices dimension (mm)					
	SU*	D*	F*	SU	D	F	SU	D	F	SU	D	F
VMP 229 x 229	x	x	x	0,04	0,05	0,05	309	309	309	309	309	309
VMP 260 x 260	x	x	x	0,05	0,06	0,07	340	340	340	340	340	340
VMP 150 x 600		x			0,08			220			670	
VMP 170 x 470			x			0,08			250			550
VMP 220 x 540	x	x	x	0,10	0,11	0,12	300	300	310	620	620	630
VMP 270 x 458			x			0,12			350			538
VMP 305 x 457	x	x	x	0,11	0,12	0,14	375	375	390	527	527	545
VMP 300 x 500			x			0,15			382			589
VMP 410 x 410			x			0,17			490			490
VMP 241 x 762			x			0,18			331			852
VMP 630 x 310	x	x	x	0,16	0,18	0,19	385	385	385	705	705	705
VMP 490 x 590	x	x	x	0,24	0,27	0,28	565	565	575	665	665	675
VMP 600 x 600			x			0,35			650			650
VMP 450 x 800	x	x	x	0,32	0,34	0,36	530	530	550	880	880	900
VMP 610 x 610			x			0,37			690			690
VMP 586 x 920	x	x	x	0,48	0,51	0,53	661	661	675	995	995	1010
VMP 588 x 908			x			0,53			680			1000
VMP 800 x 800			x			0,62			850			850
VMP 610 x 290	x	x		0,14	0,16		365	365		685	685	
VMP 2 x 610 x 290		x			0,32			385			1385	
VMP 2 x 630 x 310	x	x		0,35	0,35		385	385		1405	1405	
VMP 685 x 1100			x			0,75			765			1178
VMP 920 x 920	x	x	x	0,78	0,81	0,83	995	995	1005	995	995	1005
VMP 915 x 1118	x	x	x	0,95	0,98	1,02	990	990	1005	1193	1193	1210
VMP 1020 x 1020	x	x	x	0,96	1,00	1,04	1095	1095	1106	1095	1095	1106
VMP 1118 x 1118			x			1,25			1202			1202
VMP 1000 x 2000			x			2,00			1090			2090

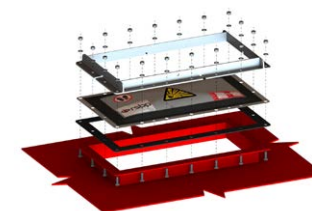

The way to install VMP

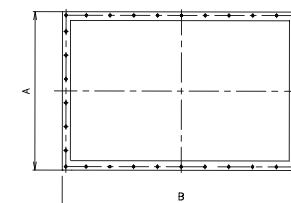

*SU – Domed triple layer venting devices with PTFE isolation / *D – Domed single layer venting devices / *F – Flat venting devices



EXPLOSION DOORS

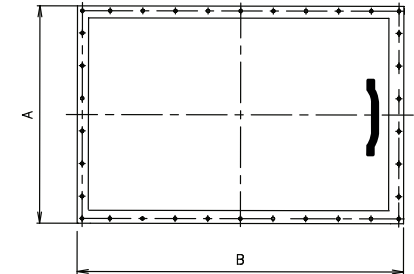

- Suitable for applications with low operational pressure and without pressure pulses
- Material: Carbon steel, galvanized
- Capability to be used repeatedly
- For technologies with very low pressure resistance

TECHNICAL PARAMETERS:

Type	Relief area (m ²)	A – outside venting devices dimension (mm)	B – outside venting devices dimension (mm)
450 x 800	0,36	590	940
282 x 637	0,17	420	740
2 x 282 x 637	0,36	420	1420

ACCESSORIES TO ALL EXPLOSION VENTING DEVICES TYPES



- Venting devices opening indicator
- Optional temperature isolation
- Optional frames for VMP – D/SU



FLEX meets the most stringent legislative requirements for flameless explosion venting devices.

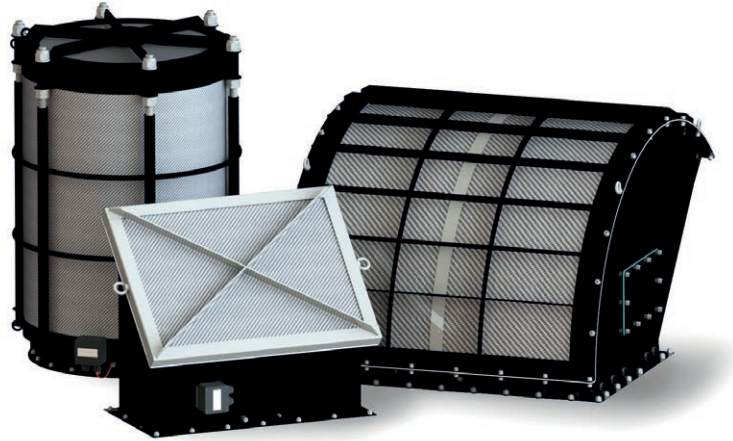

This equipment is very simple as far as maintenance and service. A normal visual control is all you need under usual operating conditions.

THE SYSTEM HAS 2 FUNCTIONS:

Explosion venting and prevention of explosion propagation into a free space are two basic functions of the system.

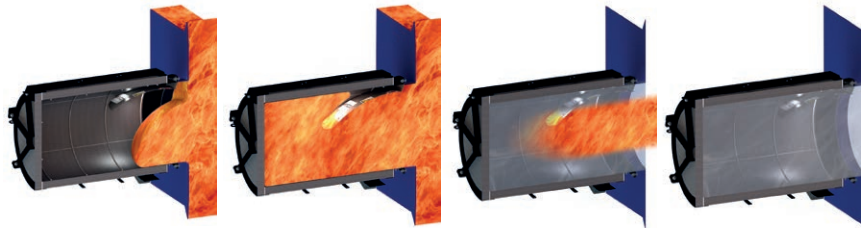

The FLEX flameless device to relieve explosion is a suitable solution for installation on technological equipment inside buildings or production halls.

FLEX guarantees explosion venting in enclosed or internal spaces without propagation of flame, dangerous pressure and heat to near surroundings, therefore the equipment and technologies that are located in hard to access spaces can be

protected by the flameless explosion venting without increased costs for building modifications that are usually related to installation of classical explosion venting equipment.

Protection of your technology by the FLEX flameless explosion venting equipment is suitable in cases, where the explosion venting is not possible to a safety zone or there is not enough space for installation of classical explosion venting equipment.

ADVANTAGES:

- Effective arrest of flame and heat and provision of a safe zone for equipment, buildings and movement of personnel
- Effective catchment of dust – no pollution of the technology or the surroundings
- Suitable for food and pharmaceutical industries
- High effectivity and reliability of the system
- Simple installation and maintenance free operation
- Elimination of high costs for building modifications
- Economically advantageous solution
- Suitable for technologies working with melt and coarse dust and light metal dust

The explosion venting device opens due to fast increasing pressure and the FLEX absorbs flame, burning dust and gases. As opposed to a classical explosion venting the FLEX system is capable to absorb these undesirable effects thanks to its construction.

The explosion venting can achieve temperatures up to 1 500 °C. During explosion venting with the FLEX flameless equipment the temperature is lowered, thanks to its design, to such temperature that is not dangerous for surrounding equipment and for work and movement of personnel.



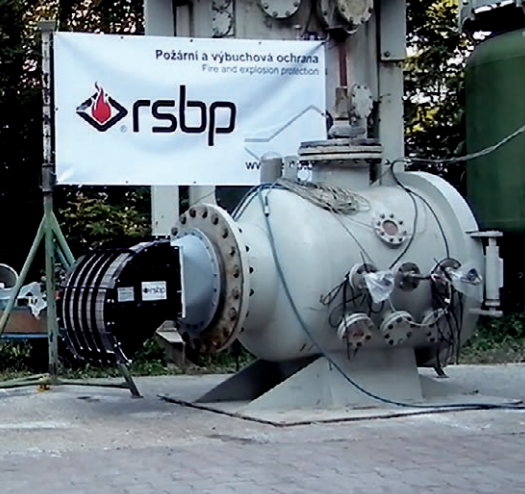

TECHNICAL PARAMETERS:

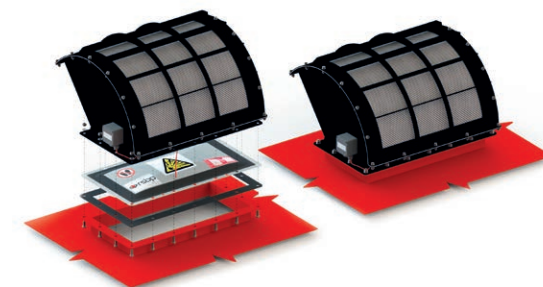
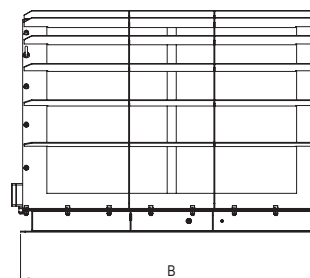
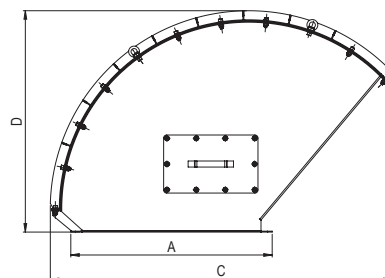
Type	A (mm)	B (mm)	C (mm)	D (mm)	d – Opening diameter (mm)	n – Number of openings (pc)	Weight (kg)
FLEX R1 PRO	390	710	635	410	14	18	40
FLEX R2 PRO	540	890	900	580	14	22	74
FLEX R3 PRO	666	1000	1130	735	14	34	109
FLEX R4 PRO	996	1198	1660	1070	14	42	215

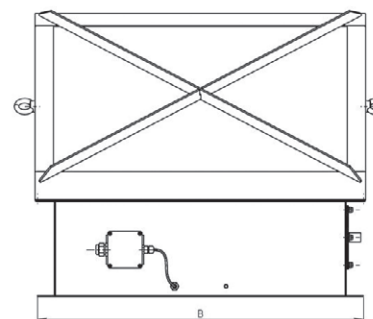
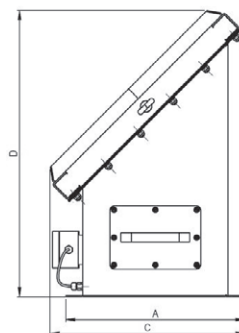

Type	A (mm)	B (mm)	C (mm)	D (mm)	d – Opening diameter (mm)	n – Number of openings (pc)	Weight (kg)
FLEX F1 PRO	225	675	265	465	14	20	24
FLEX F2 PRO	305	625	335	530	14	18	28
FLEX F3 PRO	390	710	420	620	14	18	35





TECHNICAL PARAMETERS:

Type	A (mm)	B (mm)	C (mm)	D (mm)	E (mm)	F (mm)	G (mm)	d – Opening diameter (mm)	n – Number of openings (pc)	Weight (kg)
FLEX C1 PRO	315	580	485	320	350	5	375	11	12	30
FLEX C1 PRO S	315	879	633	320	350	5	375	11	12	80
FLEX C2 PRO S	445	1075	633	450	486	5	525	13	12	87
FLEX C3 PRO S	505	1286	705	510	550	6	585	13	20	126
FLEX C4 PRO S	625	1385	1020	630	680	6	705	13	20	243
FLEX C5 PRO	815	2215	1020	820	860	6	895	13	24	291

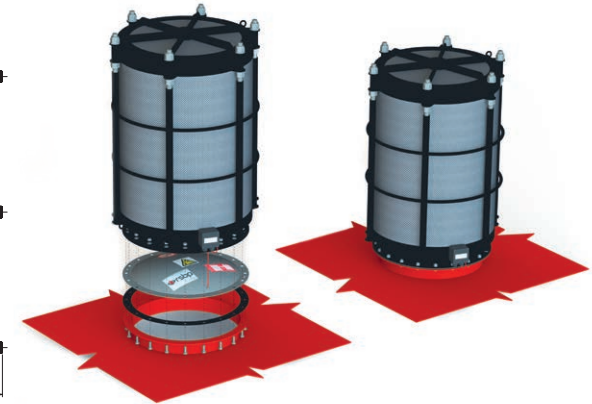
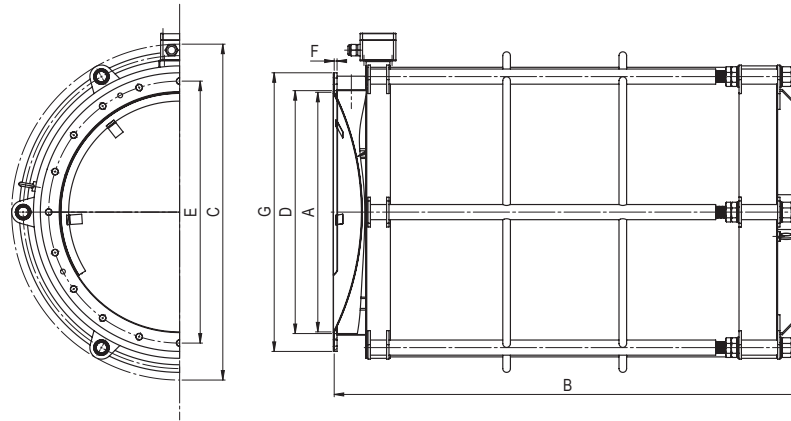

APPLICATION:

Type	Dust Type		
	Organic	Melt and coarse	Light metal dust
FLEX series R	•	•	
FLEX series F	•	•	
FLEX series C	•	•	•



B-FLAP I is a mechanical device designed to prevent propagation of flame and pressure between pieces of technology equipment during explosion. B-FLAP I is, together with other safety measures, a part of a system that protects technologies intended for operation in an explosion danger environment.

Economical solution of protection against propagation of explosion to pipes is the back pressure flap B-FLAP I.

B-FLAP I is suitable for isolation of explosion propagation between technologies as filters, cyclones and other devices with danger of dust explosions. It is suitable for pipe sizes from DN 100 to DN 800.

ADVANTAGES:

- Wide variety of sizes from DN 100 to DN 800
- Mechanical device that does not need electrical energy or activation system
- Low pressure losses
- High pressure resistance
- Optional position indicator
- Optional signalization of dirt on flap seating surface
- Simple installation, inspections and maintenance
- Low maintenance costs
- Mechanical shut-down when the flap closes
- Suitable for technologies working with light metal dust
- Possibility of complementing with the mechanism RPD (Reducer of Pressure Drop)

THE B-FLAP I INSTALLATION DIAGRAM ON A PIPE

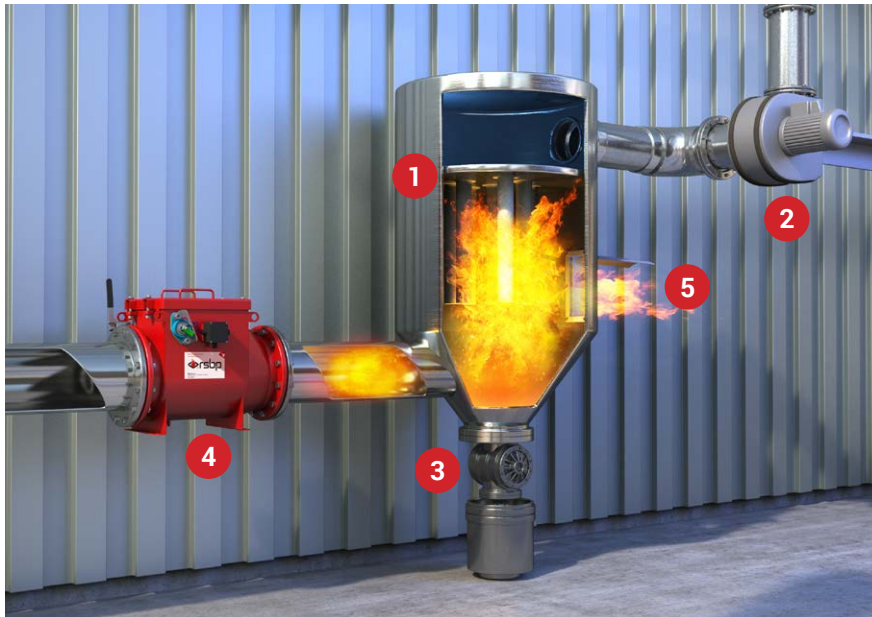

1. Filter
2. Fan
3. Rotary valve
4. Back pressure flap B-FLAP I
5. Explosion venting device

In normal operation, the back pressure flap is open due to the flow of air volume inside the piping, or it is kept in the open state by the mechanism RPD which ensures opening the flap independently of the air volume flow. This solution reduces pressure loss in the piping system significantly.

In the case of explosion, the back flap is closed and locked, thus preventing the spread of the explosion to other parts of the equipment or production technology.





TECHNICAL DATA OF THE BACK PRESSURE FLAP

MATERIAL:

- Construction steel
- Stainless steel

SURFACE FINISH:

- Komaxit (RAL 3000 – red)

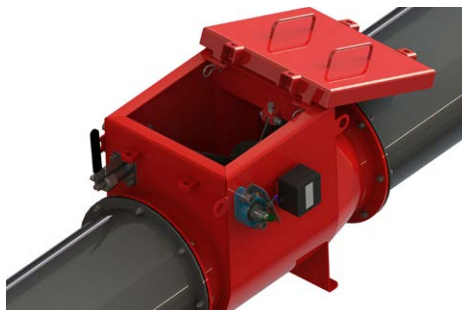

B-FLAP I maintenance access is simple

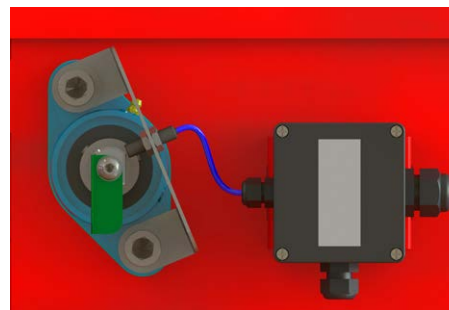

Optional electronic signalization of flap position is done by an end sensor that indicates its functional state (closed/opened).



The installation of B-FLAP I on the exhaust duct

TECHNICAL PARAMETERS:

Type	ØA (mm)	ØB (mm)	ØC (mm)	D x ØE	L (mm)	N (mm)	P (mm)	Weight (kg)	p red, max (bar)	Dust explosion class	Installation distance min – max (m)	Pressure resistance p max (bar)	Pressure loss approx. (20 m/s) (Pa)
B-FLAP I DN 100	152	132	100	4 x 9,5	280	287	244	9	0,6	St1, St2	3 - 7	1	350
B-FLAP I DN 125	177	157	125	4 x 9,5	305	308	269	11	0,6	St1, St2	3 - 7	1	215
B-FLAP I DN 150	202	182	150	6 x 9,5	330	337	294	13	0,6	St1, St2	3 - 7	1	220
B-FLAP I DN 200	253	233	200	6 x 9,5	390	387	344	18	0,6	St1, St2	3 - 7	1	230
B-FLAP I DN 250	303	283	250	6 x 9,5	510	502	417	40	0,45	St1, St2	4 - 7	0,65	270
B-FLAP I DN 300	363	337	300	8 x 9,5	580	552	467	50	0,45	St1, St2	4 - 7	0,65	270
B-FLAP I DN 315	378	352	315	8 x 9,5	600	567	482	53	0,45	St1, St2	4 - 7	0,65	290
B-FLAP I DN 355	418	392	355	8 x 9,5	630	607	522	61	0,45	St1, St2	4 - 7	0,65	320
B-FLAP I DN 400	464	438	400	8 x 9,5	695	652	568	77	0,45	St1, St2	4 - 7	0,65	330
B-FLAP I DN 450	514	488	450	8 x 9,5	750	702	619	88	0,35	St1	4 - 7	0,8	450
B-FLAP I DN 500	564	538	500	8 x 9,5	800	752	669	101	0,35	St1	4 - 7	0,8	500
B-FLAP I DN 560	664	629	560	16 x 14	930	838	745	157	0,45	St1	4 - 7	0,8	500
B-FLAP I DN 630	734	698	630	16 x 14	1005	908	815	180	0,45	St1	4 - 7	0,8	550
B-FLAP I DN 710	814	775	710	16 x 14	1156	1103	962	305	0,45	St1	3 - 7	0,7	500
B-FLAP I DN 800	904	861	800	24 x 14	1246	1193	1052	351	0,45	St1	3 - 7	0,7	500

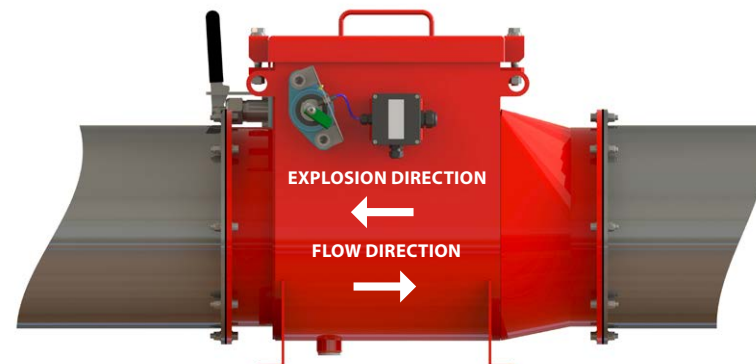
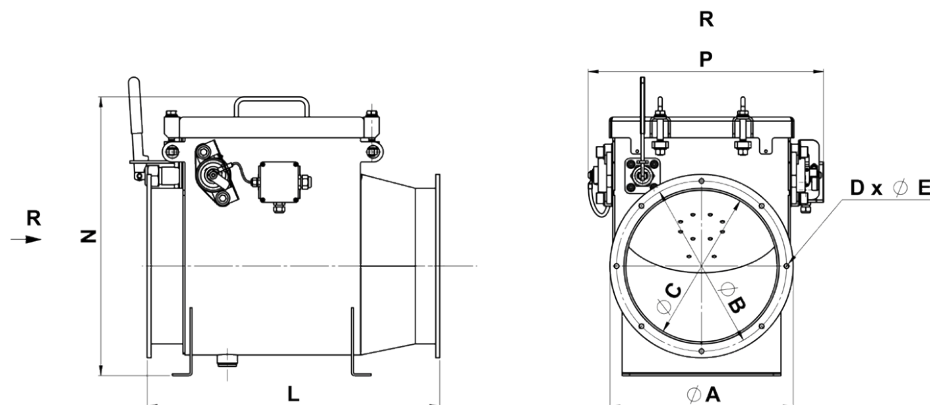



HRD barriers are characterized by extremely fast discharge of an extinguishing agent into pipes connecting pieces of technological equipment. Explosion pressure propagates through the pipes first during an explosion followed by a flame front. Both of these quantities can be detected by special detectors – both optical and pressure that were developed for the purpose.

HRD barrier is suitable for isolation of explosion propagation in pipes of filters, reservoirs, mills, crushers, separators, cyclone dryers and other devices with danger of dust explosions.

ADVANTAGES:

- High reaction speed of the system from detection to extinguishing
- Independent archiving of detector data
- Variability of detector, control unit and container unit use
- High quality components
- Customization according to customer quality wishes
- Use in inside and outside areas
- High reliability of the system



DIAGRAM OF HRD BARRIER INSTALLATION ON A PIPE

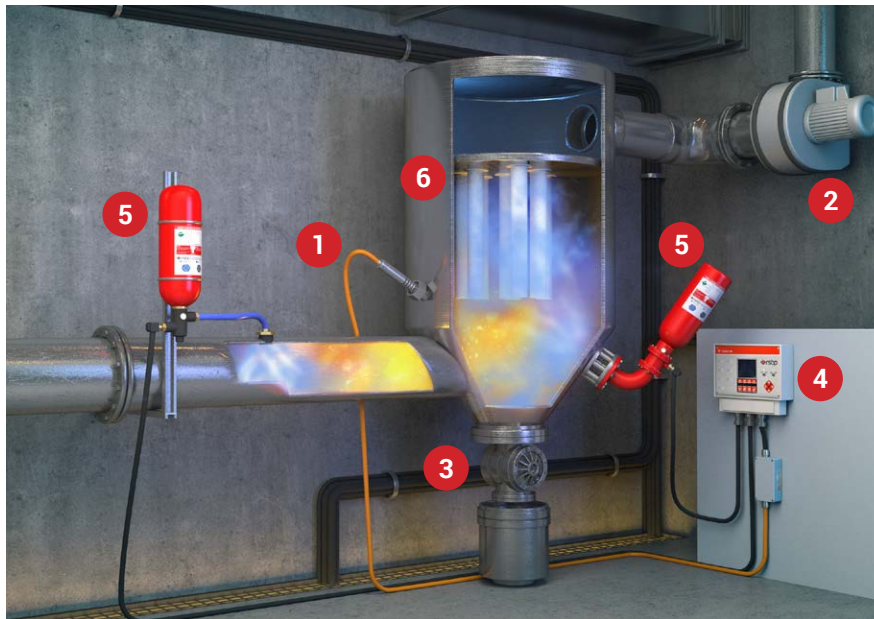

The detectors relate a signal to a control unit that activates HRD container units. The bottles are equipped by fast-opening valves capable to immediately release extinguishing agent to the protected space, and create very effective extinguishing agent barrier.

1. Explosion detector
2. Fan
3. Rotary valve
4. Control unit
5. HRD container unit
6. Filter





The quick-acting slide valve GatEx is used for complete closure of a pipe, therefore it is suitable for protection of production technologies with danger of dust explosion.

ADVANTAGES:

- Can be used for pipes above the DN 50 size
- Pressure resistance of up to 21 bar
- Extremely fast reaction time
- Short installation distance

Suitable for pneumatic conveying lines, exhausting lines and technologies constructed for maximum explosion pressure resistance (p_{max}).

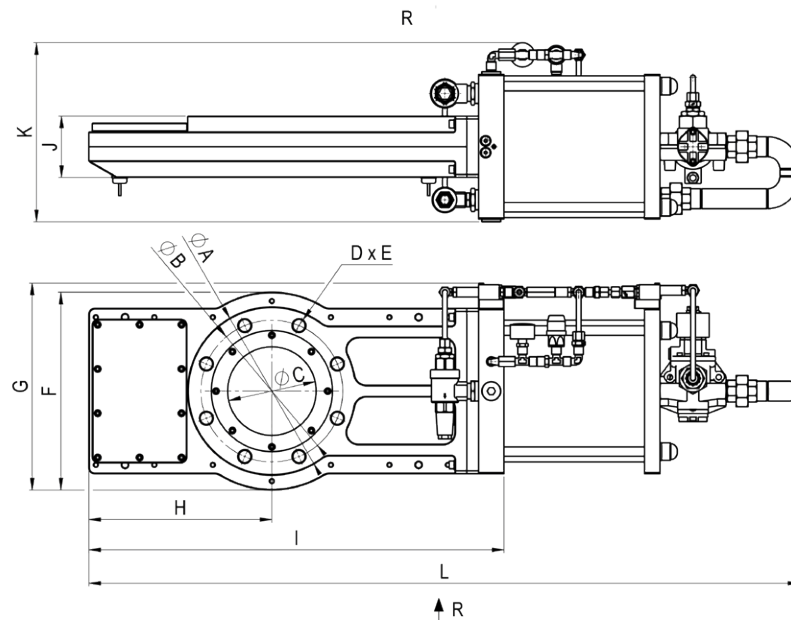
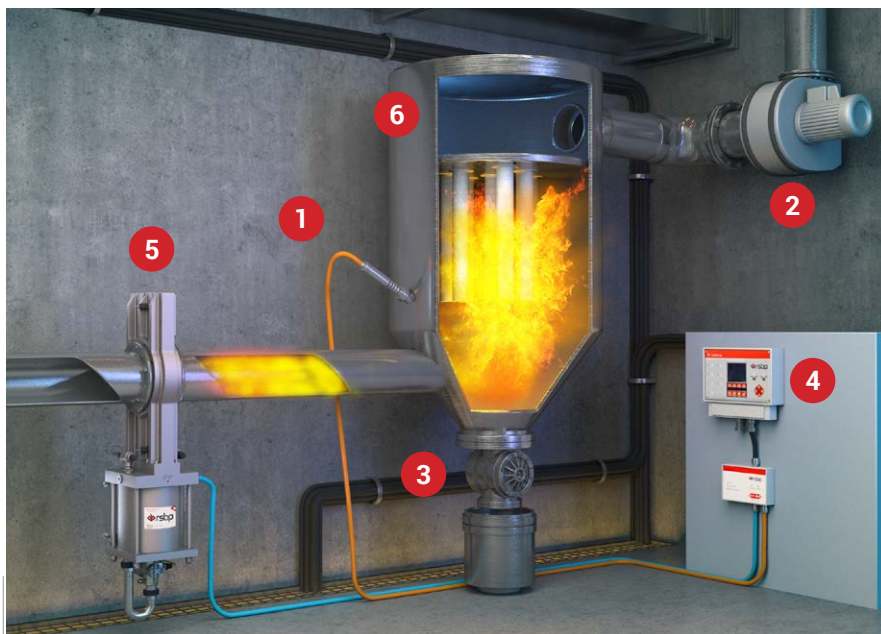

DIAGRAM OF GATEX INSTALLATION ON A PIPE



1. Explosion detector
2. Fan
3. Rotary valve
4. Control unit
5. GatEx
6. Filter

The quick-acting slide valve GatEx is activated after detection of an incipient explosion. A detector sends a signal about the incipient explosion to a control unit that in turn activates a closing mechanism of the valve. The slide valve is closed automatically.

It respects so called fail safe design that puts the slide valve into safe state (closed) in case that its reliable function cannot be guaranteed (e.g. by breaking its electrical supply or communication circuits, pressure decrease, etc.).

TECHNICAL PARAMETERS:

DN (mm)	A (mm)	B (mm)	C (mm)	D	E	F (mm)	G (mm)	H (mm)	I (mm)	J (mm)	K (mm)	L (mm)	Weight (kg)
50	165	125	50	4	M16	230	280	193	436	104	299	837	42
65	185	145	65	8	M16	245	288	202,5	468	104	299	884	47
80	200	160	80	8	M16	260	295	205	493	104	299	924	49
100	220	180	100	8	M16	280	323	235	553	104	303	1004	57
125	250	210	125	8	M16	305	335	273	628	104	303	1104	63
150	285	240	150	8	M20	335	350	310	703	104	303	1204	71



An anti-explosion diverter is a part of normal pipeline during normal operation – flow of material reverts in the anti-explosion diverter and continues on. However, in emergency it acts as a safety element, it takes an explosion that propagates along the pipe and directs it into a safety zone.

Anti-explosion diverters are suitable especially for protection of dedusting technologies, grinding equipment, transport equipment (transport systems endangered by explosion) and drying technologies.



DIAGRAM OF ANTI-EXPLOSION DIVERTER INSTALLATION ON A PIPE

1. Filter
2. Fan
3. Rotary valve
4. Explosion venting device
5. Anti-explosion diverter
6. Venting inside diverter

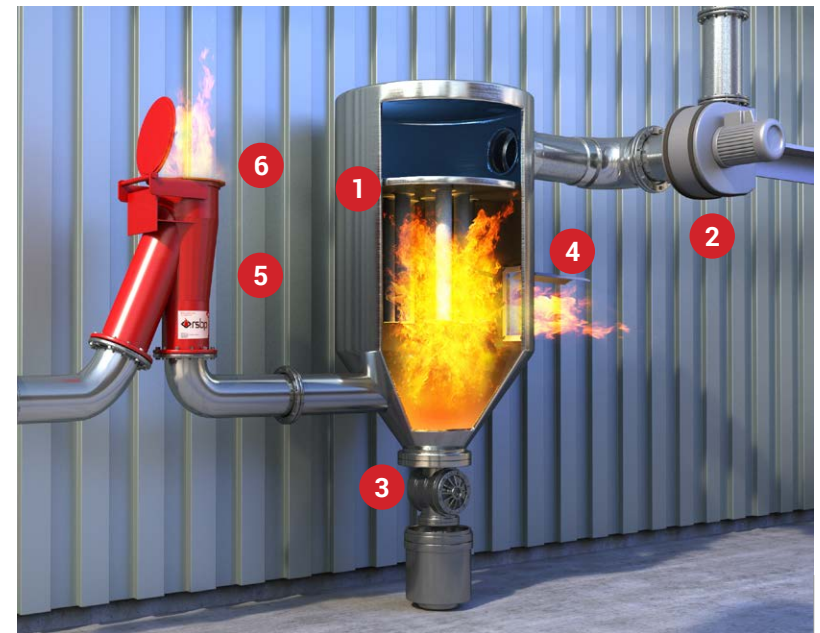

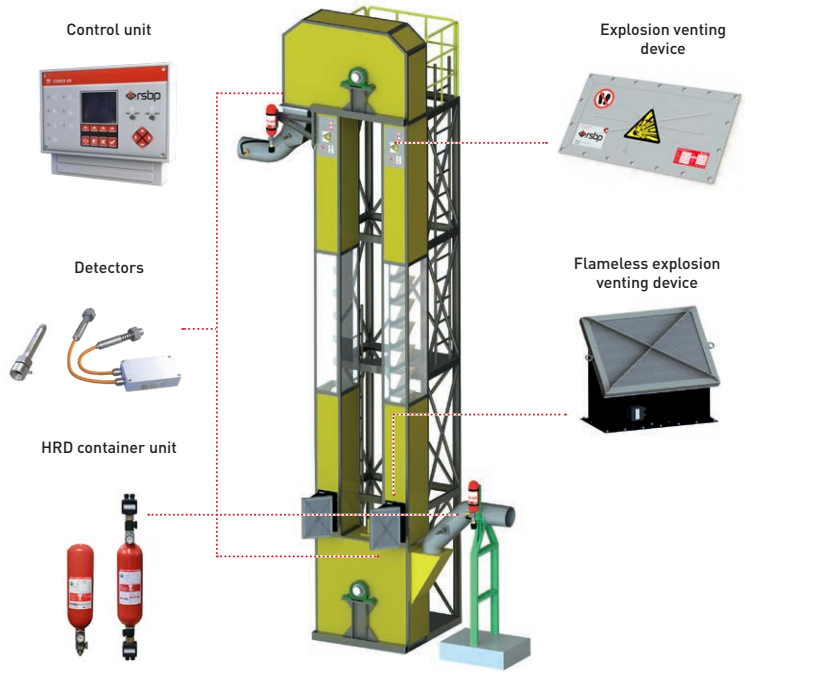

Use of compact, sophisticated, highly effective and tested ELEVEX system is safe and effective way to protect your bucket elevator against explosion effects.

ELEVEX is the effective solution of bulk material vertical transport explosion protection. ELEVEX reduces explosion pressure to an extremely low value, which means that even existing and used technologies can be safely protected in case of explosion completely without destructive effects. The list of factors that can cause an explosion in a bucket

elevator or similar vertical transport system is long, and the probability the an explosion will occur during operation is high. Although use of this system does not prevent origination of an explosion in an elevator, the actual explosion effects can be brought to a minimum.

THE MOST FREQUENT INITIATION SOURCES IN BUCKET ELEVATORS ARE:

- Sparks caused by deviation of traction system from its axis
- Sparks from the elevator drive or hot elevator surfaces caused by friction
- Glowing particles introduced together with transported material
- Bearing friction, etc.

ADVANTAGES:

- Tested protection system
- High quality of used components
- Simple installation even onto already existing technologies
- Maximum protection with minimum costs
- Suitable also for high elevators

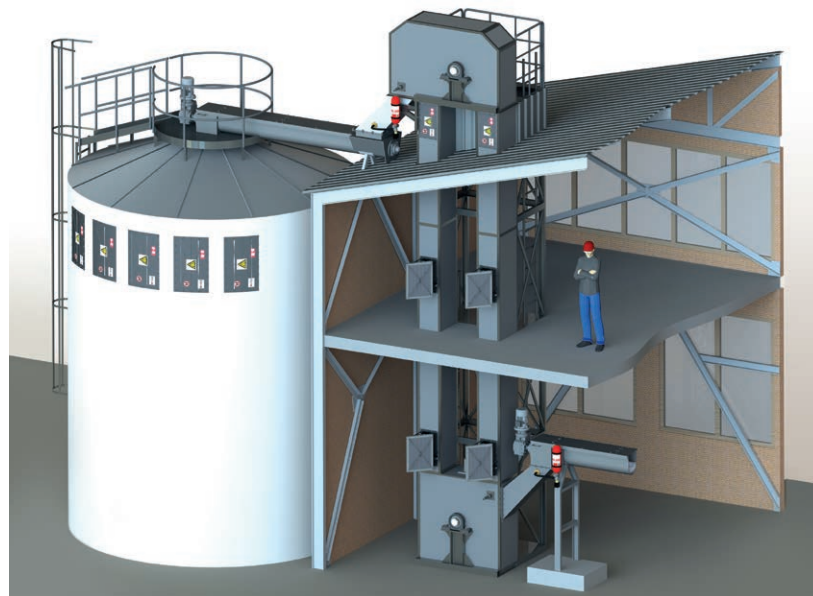

The ELEVEX system offers variability protection for both internal and external applications.

In case of explosion inside the elevator there is not only a large risk of destruction of the whole production technology, but mainly injury or death of workers. In case that an unprotected equipment is destroyed the Operator does not face only incredibly high costs related to the acquisition of a new elevator and renewing of production, but also large downtime related to this replacement or renewal of technology.



VERSIONS OF EXPLOSION PROTECTION OF BUCKET ELEVATORS

**EXPLOSION SUPPRESSION**

Explosion suppression is the most frequent and the most widely used way of explosion protection of bucket elevators.

Components:

- Explosion detector
- Barriers preventing explosion transfer at the bucket elevator entrance and exit to connected technologies and devices
- Explosion suppression at the elevator head and foot

Advantages:

- Reduces explosion pressure to an extremely low value, which means that even existing and used technologies can be safely protected in case of explosion without destructive effects
- Safe and suitable way of protection of elevators located outside and inside of buildings
- Economically advantageous solution

**EXPLOSION VENTING**

During explosion venting it is expected that the flame and pressure waves will relieve themselves through the vent opening to a safe space.

Components:

- Explosion detector
- Barriers preventing explosion transfer at the bucket elevator entrance and exit to connected technologies and devices
- Especially developed explosion venting devices or flameless devices are used for venting

Advantages:

- Extremely quick decrease of explosion effects
- Effective, economically advantageous solution, low costs and easy installation
- Optional panel opening sensors and heat insulation
- Suitable for elevators located outside of buildings
- In the case of explosion will safely protect even existing and already used technologies without destruction effects

**FLAMELESS EXPLOSION VENTING**

For flameless venting is used FLEX device, which stops flame and heat propagation and reduce explosion pressure in the same moment.

Components:

- Explosion detector
- Barriers preventing explosion transfer at the bucket elevator entrance and exit to connected technologies and devices
- Flameless explosion venting

Advantages:

- Effective arrest of flame and heat and provision of a safe zone for movement of personnel, equipment and buildings
- Effective retention of dust
- High effectivity and reliability of the system
- Simple installation and maintenance-free operation
- Elimination of high costs for building modifications
- In the case of explosion will safely protect even existing and already used technologies without destruction effects
- Economically advantageous solution

The ELEVEX system contains variable protections both for internal and external applications. The ELEVEX system offers various customer-based combinations.





RSBP spol. s r. o.
Pikartská 1337/7
716 07 Ostrava
Czech Republic

E-mail: rsbp@rsbp.cz
Phone: +420 596 252 170

www.rsbp.cz

