

SMOOTHBORE

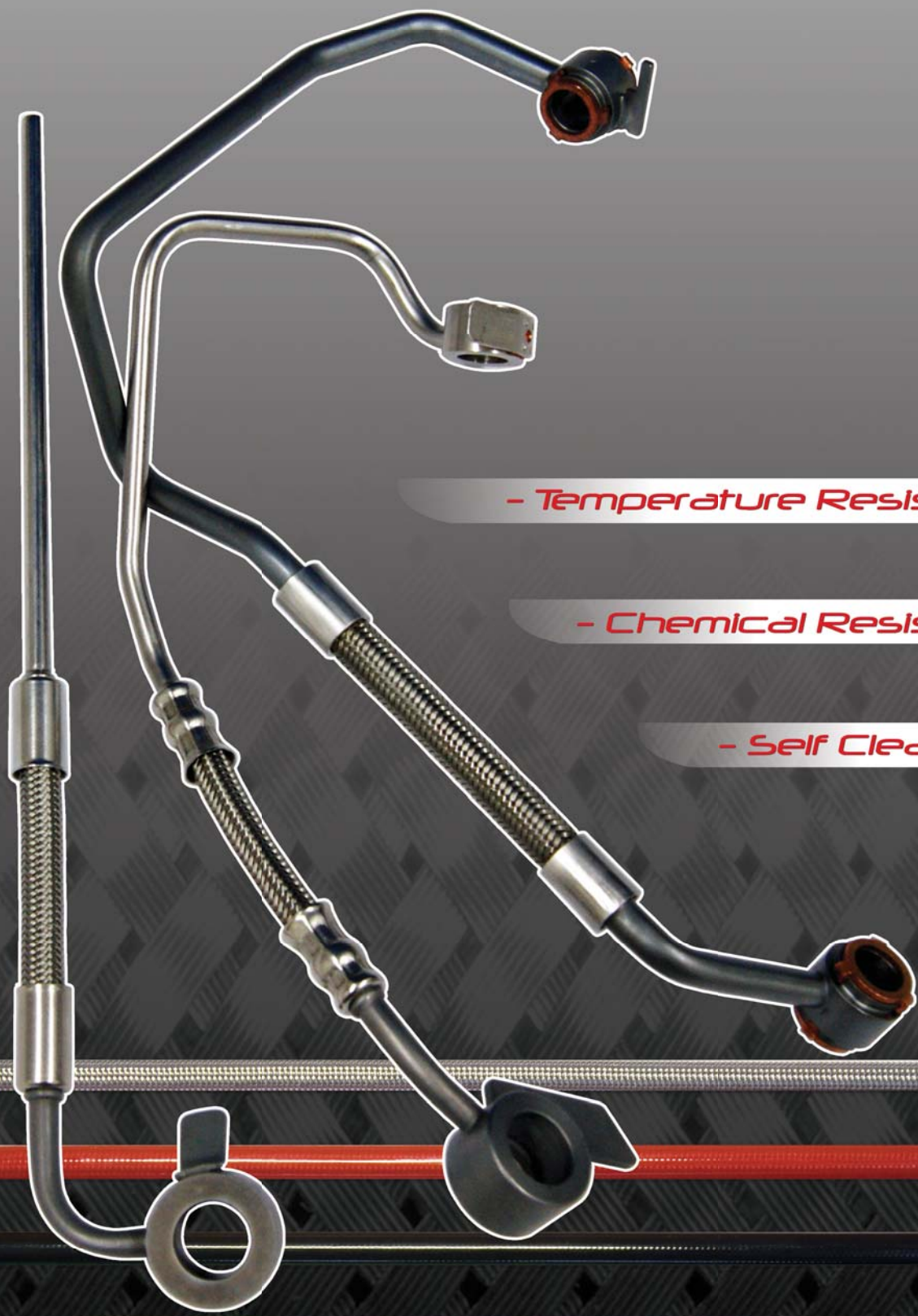

- Temperature Resistant



- Chemical Resistant

- Self Cleaning

PTFE Lined High Pressure Hose

PTFE - The Optimum Choice For Hose Linings

Section from a PTFE Molecule,
16 Angstrom Units long.

 = Fluorine Atom
 = Carbon Atom

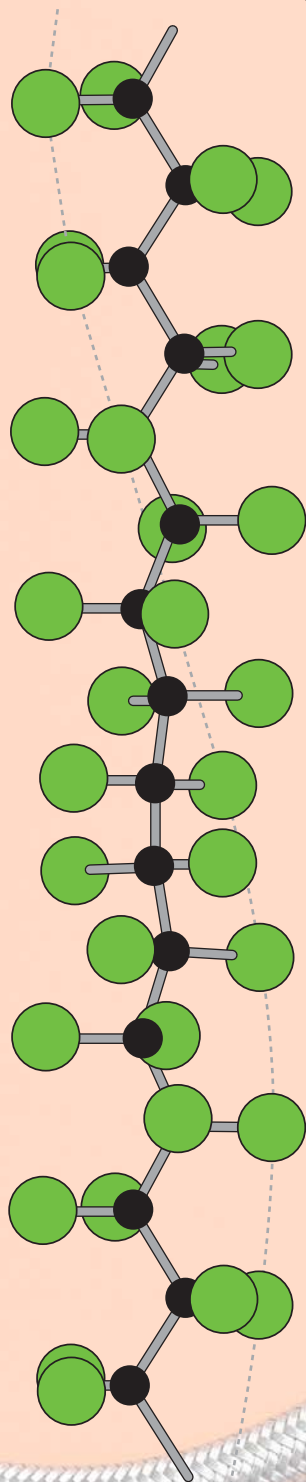

PTFE, or Polytetrafluoroethylene, comprises long-chain molecules of carbon atoms, each linked to two fluorine atoms.

The fluorine atoms provide a helical spiral which surrounds the carbon chain and protects it.

It is this structure which creates the unique properties for which PTFE is well-known.

Excellent Chemical Resistance

PTFE is renowned as the most chemically resistant material known. Only a very few, very unusual substances and conditions can affect it, like Fluorine gas at high temperature and pressure and Liquid, boiling sodium metal.

PTFE lined hoses can therefore be used for a wider variety of chemicals than any other hose type, making it the ideal choice for very corrosive chemical applications and multi-product applications.

Non-Stick Surface

The use of PTFE as a surface for cookware products has demonstrated to the world how easily cleanable PTFE surfaces are.

This means that PTFE lined hoses can be purged 100% clean more quickly, easily and reliably than any other type of hose.

Excellent Temperature Range

The cookware application also demonstrates another of PTFE's many attributes - temperature resistance. PTFE itself can be used as a hose liner at temperatures from -150°C up to $+260^{\circ}\text{C}$, dependent upon the hose design and the application conditions.

This is the widest temperature range of any rubber or plastic hose lining material.

Hose Design

The only issue with PTFE as a hose lining material is the best way it can be integrated in to the hose design. This is where Aflex Hose have a proven record of success over the last 30 years.

Contents

| | |
|---|-------------------------|
| Front Cover | Page 1 |
| PTFE - The Optimum Choice For Hose Linings | Page 2 |
| Contents | Page 3 |
| Standard Smoothbore Hose Grades | Page 4 |
| SW (Standard Wall), HW (Heavy Wall), MW (Medium Wall) and "Dash" Sizes | |
| Specifications for Standard Hose Grades, Single Wire Braid | Page 5 |
| Specifications for Standard Hose Grades, Double Wire Braid | Page 6 |
| High Pressure Smoothbore Hose Grades | Page 7 |
| Alternative PTFE Tube Liners | Page 8 |
| HPG (High Pressure Gas) and AS (Antistatic) | |
| Plastic or Rubber Hose Covers | Page 9 |
| Smoothbore Hose End Fittings - PTFE Tail and Hydraulic Tail | Page 10 |
| List of PTFE Tail End Fittings and Ferrules for Standard Smoothbore Hose Grades | Page 11 |
| How To Order Smoothbore Hose, End Fittings or Assemblies | Page 12 |
| Smoothbore Hose - Special Usage Conditions | Page 13 |
| Quality Assurance and Certification | Page 14 |
| Correct Hose Configuration & Length Calculations | |
| - For Bend Radius | Page 15 |
| - For Abrasion & Torque | Page 16 |
| - For Length Calculation | Page 17 |
| Conditions of Sale | Page 18 & 19 |
| Back Cover | Page 20 |

Standard Smoothbore Hose Grades

Construction

Hose Liner: Seamless extruded PTFE tube. The extrusion, heat treatment and quality control programmes are designed to produce the best quality PTFE tube possible, ensuring minimum porosity and maximum flexibility.

Hose Braid: Braided from AISI grade 304 stainless steel wire, bright hard drawn to a minimum 1700 N/mm² tensile strength. The braiding process is closely controlled to ensure even tensions and the correct braid angle, to give minimum expansion/contraction under pressure.

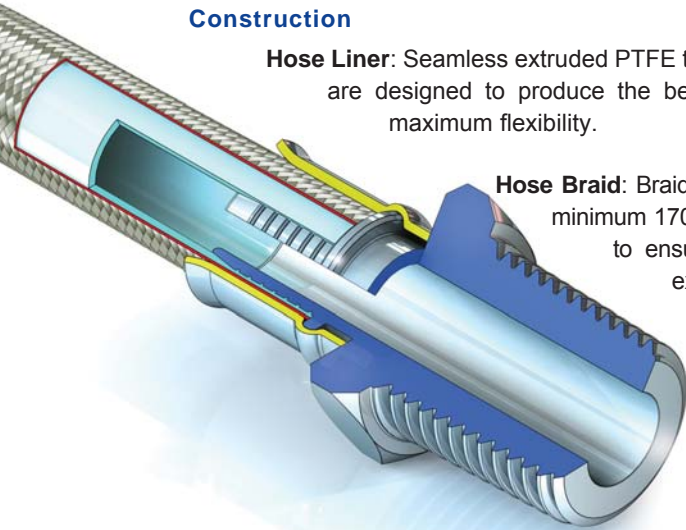

GRADES AVAILABLE, and APPLICATIONS

There are 3 standard grades available, with a Single SS wire braid (SB) or a Double wire braid (DB).

Single Braid is suitable for applications in general. Double Braid is required for higher pressures and increased kink resistance.

Grade SW, SB - Standard Wall, Single Braid (or DB, Double Braid)

For general purpose use, including high and low pressure steam, chemicals, paints, inks, adhesives, brake fluids, fuels, oils, detergents, refrigerants and foodstuffs.

PTFE lined hose is the optimum hose product wherever excellent chemical resistance, temperature resistance and/or internal “non-stick” cleanability are primary requirements of the application.

Grade HW, SB - Heavy Wall, Single Braid (or DB, Double Braid)

For heavy duty use, also for use with gases up to 100 Bar pressure, and for hot/cold cycling applications.

Grade MW, SB - Medium Wall, Single Braid, also called Hyperline SB (or DB, Double Braid)

The Hyperline name is applied to Aflex PTFE hose products which have an oversize bore, to enable assembly with standard Hydraulic End Fittings. In most cases, these sizes are the same as the conventional “dash” hose size range, as indicated in the specifications.

SPECIFICATIONS and SIZE RANGES

SW, HW & MW Single Braid (SB) Hose - Page 5

SW, HW & MW Double Braid (DB) Hose - Page 6

Alternative PTFE Tube Liners Page 8

The standard grades described above are not suitable for applications using high pressure gas or electrostatic charging fluids.

The alternative PTFE tube liners described on page 9 are required to satisfy such applications.

Plastic or Rubber Hose Covers - Page 9

For external abrasion resistance, ease of cleaning, colour identification or for printing, plastic or rubber covers may be applied as described on page 9.

Specifications for Standard Single Braid Hose and Hose Properties

SPECIFICATIONS and SIZE RANGE

For Single Stainless Steel wire braid hose, for Standard Grade and AS Grade

STANDARD WALL, SINGLE BRAID (SW, SB)

| Bore Size (Nominal) | Bore Size (Actual) | | PTFE Tube Wall Thickness | | Braid Outside Diameter | | Minimum Bend Radius | | Maximum Working Pressure | | Weight per Unit Length | | *Part Number |
|---------------------|--------------------|-------|--------------------------|-------|------------------------|-------|---------------------|-------|--------------------------|------|------------------------|--------|-----------------|
| | mm | in | mm | in | mm | in | mm | in | Bar | psi | Kg/mt | Lbs/Ft | |
| 1/8 | 3.17 | 0.125 | 0.76 | 0.030 | 5.85 | 0.230 | 22 | 7/8 | 290 | 4220 | .065 | .044 | 70-100-02-01-02 |
| 3/16 | 4.76 | 0.188 | 0.76 | 0.025 | 7.40 | 0.291 | 40 | 15/8 | 265 | 3856 | .080 | .054 | 70-100-03-01-02 |
| 1/4 | 6.35 | 0.250 | 0.63 | 0.025 | 8.50 | 0.335 | 60 | 23/8 | 240 | 3492 | .093 | .062 | 70-100-04-01-02 |
| 5/16 | 7.94 | 0.313 | 0.63 | 0.025 | 10.15 | 0.400 | 70 | 27/8 | 200 | 2910 | .110 | .074 | 70-100-05-01-02 |
| 3/8 | 9.53 | 0.375 | 0.63 | 0.025 | 11.75 | 0.463 | 80 | 32/8 | 190 | 2765 | .124 | .083 | 70-100-06-01-02 |
| 1/2 | 12.70 | 0.500 | 0.76 | 0.030 | 14.95 | 0.589 | 110 | 43/8 | 150 | 2183 | .207 | .139 | 70-100-08-01-02 |
| 5/8 | 15.88 | 0.625 | 0.76 | 0.030 | 18.35 | 0.722 | 150 | 6 | 110 | 1601 | .255 | .171 | 70-100-10-01-02 |
| 3/4 | 19.05 | 0.750 | 0.76 | 0.030 | 21.65 | 0.852 | 200 | 77/8 | 80 | 1164 | .315 | .211 | 70-100-12-01-02 |
| 1 | 25.40 | 1.000 | 1.00 | 0.039 | 28.15 | 1.108 | 300 | 117/8 | 55 | 800 | .430 | .288 | 70-100-16-01-02 |

HEAVY WALL, SINGLE BRAID (HW, SB)

| Bore Size (Nominal) | Bore Size (Actual) | | PTFE Tube Wall Thickness | | Braid Outside Diameter | | Minimum Bend Radius | | Maximum Working Pressure | | Weight per Unit Length | | *Part Number |
|---------------------|--------------------|-------|--------------------------|-------|------------------------|-------|---------------------|-------|--------------------------|------|------------------------|--------|-----------------|
| | mm | in | mm | in | mm | in | mm | in | Bar | psi | Kg/mt | Lbs/Ft | |
| 1/8 | 3.17 | 0.125 | 1.00 | 0.039 | 6.10 | 0.240 | 20 | 7/8 | 290 | 4220 | .068 | .046 | 70-200-02-01-02 |
| 3/16 | 4.76 | 0.188 | 1.00 | 0.039 | 7.65 | 0.301 | 29 | 11/8 | 270 | 3929 | .087 | .058 | 70-200-03-01-02 |
| 1/4 | 6.35 | 0.250 | 1.00 | 0.039 | 9.25 | 0.364 | 30 | 12/8 | 260 | 3783 | .113 | .076 | 70-200-04-01-02 |
| 5/16 | 7.94 | 0.313 | 1.00 | 0.039 | 10.90 | 0.429 | 40 | 15/8 | 230 | 3347 | .135 | .091 | 70-200-05-01-02 |
| 3/8 | 9.53 | 0.375 | 1.00 | 0.039 | 12.50 | 0.492 | 55 | 22/8 | 200 | 2910 | .153 | .103 | 70-200-06-01-02 |
| 1/2 | 12.70 | 0.500 | 1.00 | 0.039 | 15.60 | 0.614 | 85 | 33/8 | 160 | 2328 | .240 | .161 | 70-200-08-01-02 |
| 5/8 | 15.88 | 0.625 | 1.30 | 0.051 | 19.10 | 0.752 | 110 | 43/8 | 130 | 1892 | .292 | .196 | 70-200-10-01-02 |
| 3/4 | 19.05 | 0.750 | 1.30 | 0.051 | 22.05 | 0.868 | 145 | 59/8 | 92 | 1339 | .344 | .231 | 70-200-12-01-02 |
| 1 | 25.40 | 1.000 | 1.50 | 0.059 | 28.80 | 1.134 | 260 | 102/8 | 69 | 1004 | .470 | .315 | 70-200-16-01-02 |

MEDIUM WALL SINGLE BRAID (MW, SB), also referred to as HYPERLINE SB

The Hyperline MW, SB Range meets or exceeds SAE 100R14 standard.

| Bore Size (Nominal) BB = Big Bore | Bore Size (Actual) | | Dash Size Reference (if any) | PTFE Tube Wall Thickness | | Braid Outside Diameter | | Minimum Bend Radius | | Maximum Working Pressure | | Weight per Unit Length | | *Part Number |
|--------------------------------------|--------------------|-------|------------------------------|--------------------------|-------|------------------------|-------|---------------------|------|--------------------------|------|------------------------|--------|-----------------|
| | mm | in | | mm | in | mm | in | mm | in | Bar | psi | Kg/mt | Lbs/Ft | |
| 1/16 BB | 2.0 | 0.079 | -2 | 1.00 | 0.040 | 5.00 | 0.197 | 13 | 1/2 | 450 | 6500 | .045 | .030 | 70-300-02-01-02 |
| 1/8 BB | 3.5 | 0.138 | -3 | 1.00 | 0.040 | 6.45 | 0.254 | 20 | 3/4 | 350 | 5076 | .070 | .047 | 70-300-03-01-02 |
| 3/16 BB | 5.0 | 0.200 | -4 | 0.76 | 0.030 | 7.65 | 0.301 | 45 | 13/4 | 290 | 4206 | .078 | .052 | 70-400-03-01-02 |
| 1/4 BB | 6.7 | 0.264 | -5 | 0.76 | 0.030 | 9.30 | 0.366 | 60 | 23/8 | 240 | 3480 | .110 | .074 | 70-400-04-01-02 |
| 5/16 BB | 8.4 | 0.335 | -6 | 0.76 | 0.030 | 10.72 | 0.422 | 70 | 23/4 | 220 | 3190 | .136 | .091 | 70-400-05-01-02 |
| 3/8 BB | 10.0 | 0.394 | -7 | 0.76 | 0.030 | 12.75 | 0.500 | 80 | 3 | 190 | 2755 | .166 | .111 | 70-400-06-01-02 |
| 1/2 BB | 13.3 | 0.536 | -10 | 0.76 | 0.030 | 16.35 | 0.644 | 130 | 5 | 150 | 2175 | .210 | .141 | 70-400-08-01-02 |
| 5/8 BB | 16.5 | 0.654 | -12 | 0.84 | 0.033 | 19.50 | 0.768 | 163 | 61/2 | 130 | 1885 | .280 | .188 | 70-400-10-01-02 |
| 3/4 BB | 19.8 | 0.780 | | 1.00 | 0.040 | 22.50 | 0.860 | 180 | 7 | 110 | 1595 | .327 | .219 | 70-400-12-01-02 |
| 1 BB | 26.4 | 1.040 | | 1.00 | 0.040 | 30.10 | 1.190 | 230 | 9 | 80 | 1160 | .524 | .351 | 70-400-16-01-02 |

* For Anti-Static Grade, add 10 to the 3-digit part number e.g. 70-100- becomes 70-110

Note: Many of the sizes of hose and fittings listed above are available as ex-stock items and are priced accordingly. However, some of the less popular items are not always in stock, and may therefore incur a minimum order charge or a set-up charge for smaller quantities. Aflex Hose will advise when the enquiry is made.

Temperature & Pressure

- Temperature affects the Maximum Working Pressure (MWP) as listed above, so for temperatures above 130°C reduce the MWP by 0.75% for each 1°C above 130°C. Example: at 180°C, reduce the MWP by $(180 - 130) \times 0.75 = 37.5\%$.
- Pressure Ratings above 100 Bar (1500 psi) only apply for the transfer of non-penetrating fluids. If gases or penetrating fluids are used in the application, or used during pressure testing at pressures above 100 Bar, HPG grade hose is required.
- Maximum Working Pressures (MWP) listed are calculated on the basis of a 3:1 safety factor relative to the burst pressure, so Burst Pressure = 3 x MWP. If MWP is required based on a 4:1 safety factor, multiply the listed value by 0.75.

Specifications for Standard Double Braid Hose

SPECIFICATIONS and SIZE RANGE - For Double Stainless Steel wire braid hose (DB Grade) and Antistatic (AS, DB) Grade.

STANDARD WALL, DOUBLE BRAID (SW, DB)

| Bore Size (Nominal) | Bore Size (Actual) | | PTFE Tube Wall Thickness | | Braid Outside Diameter | | Minimum Bend Radius | | Maximum Working Pressure | | Weight per Unit Length | | *Part Number |
|---------------------|--------------------|-------|--------------------------|-------|------------------------|-------|---------------------|--------|--------------------------|------|------------------------|--------|-----------------|
| | mm | in | mm | in | mm | in | mm | in | Bar | psi | Kg/mt | Lbs/Ft | |
| 1/8 | 3.17 | 0.125 | 0.76 | 0.030 | 6.85 | 0.270 | 20 | 7/8 | 360 | 5238 | .100 | .067 | 70-100-02-02-02 |
| 3/16 | 4.76 | 0.188 | 0.76 | 0.025 | 8.70 | 0.343 | 30 | 1 1/4 | 330 | 4802 | .135 | .091 | 70-100-03-02-02 |
| 1/4 | 6.35 | 0.250 | 0.63 | 0.025 | 10.05 | 0.396 | 40 | 1 5/8 | 290 | 4220 | .160 | .107 | 70-100-04-02-02 |
| 5/16 | 7.94 | 0.313 | 0.63 | 0.025 | 11.55 | 0.455 | 50 | 2 | 250 | 3638 | .190 | .127 | 70-100-05-02-02 |
| 3/8 | 9.53 | 0.375 | 0.63 | 0.025 | 13.35 | 0.526 | 60 | 2 3/8 | 230 | 3347 | .214 | .143 | 70-100-06-02-02 |
| 1/2 | 12.70 | 0.500 | 0.76 | 0.030 | 16.40 | 0.646 | 90 | 3 5/8 | 180 | 2629 | .341 | .229 | 70-100-08-02-02 |
| 5/8 | 15.88 | 0.625 | 0.76 | 0.030 | 19.95 | 0.785 | 130 | 5 1/8 | 135 | 1964 | .416 | .279 | 70-100-10-02-02 |
| 3/4 | 19.05 | 0.750 | 0.76 | 0.030 | 23.10 | 0.910 | 170 | 6 3/4 | 100 | 1455 | .503 | .337 | 70-100-12-02-02 |
| 1 | 25.40 | 1.000 | 1.00 | 0.039 | 29.60 | 1.165 | 270 | 10 3/4 | 70 | 1019 | .700 | .469 | 70-100-16-02-02 |

HEAVY WALL, DOUBLE BRAID (HW, DB)

| Bore Size (Nominal) | Bore Size (Actual) | | PTFE Tube Wall Thickness | | Braid Outside Diameter | | Minimum Bend Radius | | Maximum Working Pressure | | Weight per Unit Length | | *Part Number |
|---------------------|--------------------|-------|--------------------------|-------|------------------------|-------|---------------------|--------|--------------------------|------|------------------------|--------|-----------------|
| | mm | in | mm | in | mm | in | mm | in | Bar | psi | Kg/mt | Lbs/Ft | |
| 1/8 | 3.17 | 0.125 | 1.00 | 0.039 | 7.05 | 0.278 | 18 | 3/4 | 350 | 5093 | .108 | .072 | 70-200-02-02-02 |
| 3/16 | 4.76 | 0.188 | 1.00 | 0.039 | 8.90 | 0.350 | 25 | 1 | 320 | 4656 | .140 | .094 | 70-200-03-02-02 |
| 1/4 | 6.35 | 0.250 | 1.00 | 0.039 | 10.75 | 0.423 | 26 | 1 1/8 | 310 | 4511 | .183 | .123 | 70-200-04-02-02 |
| 5/16 | 7.94 | 0.313 | 1.00 | 0.039 | 12.35 | 0.486 | 35 | 1 1/2 | 275 | 4001 | .210 | .141 | 70-200-05-02-02 |
| 3/8 | 9.53 | 0.375 | 1.00 | 0.039 | 14.10 | 0.555 | 50 | 2 | 240 | 3492 | .243 | .163 | 70-200-06-02-02 |
| 13/32 | 10.32 | 0.406 | 1.00 | 0.039 | 15.05 | 0.593 | 60 | 2 3/8 | 230 | 3347 | .258 | .173 | 70-500-13-02-02 |
| 1/2 | 12.70 | 0.500 | 1.00 | 0.039 | 16.90 | 0.665 | 75 | 3 | 200 | 2910 | .374 | .251 | 70-200-08-02-02 |
| 5/8 | 15.88 | 0.625 | 1.30 | 0.051 | 20.75 | 0.817 | 100 | 4 | 155 | 2255 | .452 | .303 | 70-200-10-02-02 |
| 3/4 | 19.05 | 0.750 | 1.30 | 0.051 | 23.80 | 0.937 | 135 | 5 3/8 | 110 | 1601 | .532 | .356 | 70-200-12-02-02 |
| 1 | 25.40 | 1.000 | 1.50 | 0.059 | 30.70 | 1.209 | 250 | 9 7/8 | 84 | 1222 | .730 | .489 | 70-200-16-02-02 |
| 1 1/4 | 31.75 | 1.250 | 1.50 | 0.059 | 36.90 | 1.453 | 400 | 15 3/4 | 75 | 1091 | .905 | .637 | 70-200-20-02-02 |
| 1 1/2 | 38.10 | 1.500 | 1.50 | 0.059 | 43.75 | 1.722 | 800 | 31 1/2 | 65 | 946 | 1.170 | .784 | 70-200-24-02-02 |
| 2 | 50.80 | 2.000 | 1.50 | 0.059 | 56.40 | 2.221 | 1200 | 47 1/4 | 40 | 582 | 1.610 | 1.079 | 70-200-32-02-02 |

MEDIUM WALL, DOUBLE BRAID (MW, DB) also referred to as HYPERLINE SB, DB

| Bore Size (Nominal) BB = Big Bore | Bore Size (Actual) | | Dash Size Reference (if any) | PTFE Tube Wall Thickness | | Braid Outside Diameter | | Minimum Bend Radius | | Maximum Working Pressure | | Weight per Unit Length | | *Part Number |
|--------------------------------------|--------------------|-------|------------------------------|--------------------------|-------|------------------------|-------|---------------------|-------|--------------------------|------|------------------------|--------|-----------------|
| | mm | in | | mm | in | mm | in | mm | in | Bar | psi | Kg/mt | Lbs/Ft | |
| 1/16 BB | 2.0 | 0.079 | -2 | 1.00 | 0.040 | 6.00 | 0.236 | 11 | 1/2 | 540 | 7800 | .075 | .050 | 70-300-02-02-02 |
| 1/8 BB | 3.5 | 0.138 | -3 | 1.00 | 0.040 | 7.45 | 0.293 | 18 | 3/4 | 350 | 5000 | .111 | .074 | 70-300-03-02-02 |
| 3/16 BB | 5.0 | 0.200 | -4 | 0.76 | 0.030 | 8.80 | 0.347 | 35 | 1 3/8 | 340 | 4900 | .128 | .086 | 70-400-03-02-02 |
| 1/4 BB | 6.7 | 0.264 | -5 | 0.76 | 0.030 | 11.00 | 0.433 | 50 | 2 | 320 | 4600 | .170 | .114 | 70-400-04-02-02 |
| 5/16 BB | 8.5 | 0.335 | -6 | 0.76 | 0.030 | 11.82 | 0.466 | 60 | 2 3/8 | 270 | 3900 | .215 | .144 | 70-400-05-02-02 |
| 3/8 BB | 10.0 | 0.394 | | 0.76 | 0.030 | 14.20 | 0.560 | 80 | 3 | 230 | 3300 | .260 | .174 | 70-400-06-02-02 |
| 1/2 BB | 13.6 | 0.536 | -10 | 0.76 | 0.030 | 17.35 | 0.684 | 110 | 4 3/8 | 180 | 2600 | .350 | .234 | 70-400-08-02-02 |
| 5/8 BB | 16.6 | 0.654 | -12 | 0.84 | 0.033 | 20.80 | 0.820 | 140 | 5 1/2 | 130 | 1900 | .450 | .300 | 70-400-10-02-02 |
| 3/4 BB | 19.8 | 0.780 | | 1.00 | 0.040 | 24.00 | 0.946 | 160 | 6 1/2 | 120 | 1700 | .520 | .350 | 70-400-12-02-02 |
| 1 BB | 26.4 | 1.040 | | 1.00 | 0.040 | 31.70 | 1.249 | 210 | 8 1/4 | 100 | 1400 | .830 | .550 | 70-400-16-02-02 |

* For Anti-Static Grade, add 10 to the 3-digit part number e.g. 70-100 becomes 70-110.

For High Pressure Gas Grade, add 20, eg 70-200- becomes 70-220.

Note: A few of the sizes of hose and fittings listed above are available as ex-stock items and are priced accordingly. However, most of the items are not stocked, and will therefore incur a minimum order charge or a set-up charge for small quantities.

Temperature & Pressure

- Temperature affects the Maximum Working Pressure (MWP) as listed above, so for temperatures above 130°C reduce the MWP by 0.75% for each 1°C above 130°C. Example: at 180°C, reduce the MWP by $(180 - 130) \times 0.75 = 37.5\%$.
- Pressure Ratings above 100 Bar (1500 psi) only apply for the transfer of non-penetrating fluids. If gases or penetrating fluids are used in the application, or used during pressure testing at pressures above 100 Bar, HPG grade hose is required.
- Maximum Working Pressures (MWP) listed are calculated on the basis of a 3:1 safety factor relative to the burst pressure, so Burst Pressure = 3 x MWP. If MWP is required based on a 4:1 safety factor, multiply the listed value by 0.75.

High Pressure Smoothbore Hose Grades

Construction

Hose Liner: Seamless extruded PTFE tube. The extrusion, heat treatment and quality control programmes are designed to produce the best quality PTFE tube possible, ensuring minimum porosity and maximum flexibility.

Hose Braids: 2 braid materials are utilised:

Aramid Fibre Braid - a black aramid fibre named "Tecnora", which is a high technology fibre, with tensile, abrasion and temperature properties significantly better than the older Aramid products like Kevlar.

Stainless Steel Braid - Braided from AISI grade 304 stainless steel wire, bright hard drawn to a minimum 1700 N/mm² tensile strength. The braiding process is closely controlled to ensure even tensions and the correct braid angle, to give minimum expansion/contraction under pressure.

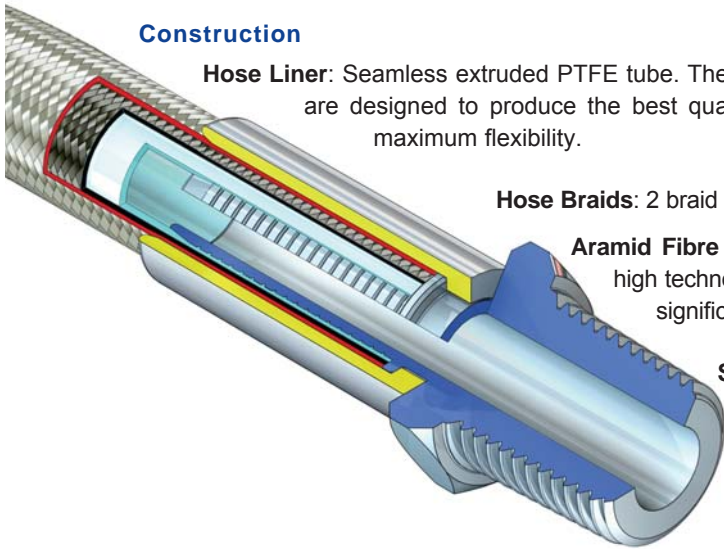

There are many different applications for PTFE lined smoothbore hose which is subjected to high pressures in service, and each application has its own individual set of requirements.

Aflex Hose are able to provide different specifications of high pressure hose which are custom designed for particular applications or testing procedures where pressures exceed 100 Bar (1500 psi) for gases, or the listed maximum pressures for fluids.

Designs include (but are not limited to) the following:

Tecnora (Aramid Fibre) Braid + Stainless Steel Wire Overbraid Hose



High Pack Stainless Steel Wire Braid Hose

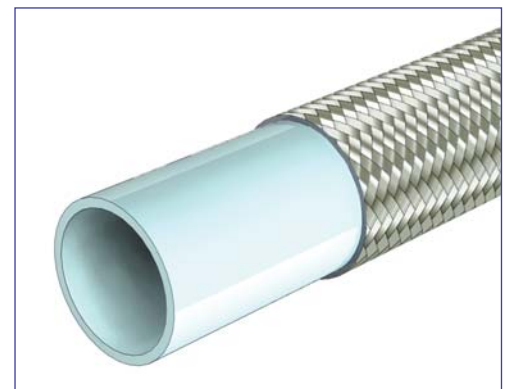

The custom design will include the size, wall thickness and quality of the PTFE tube and the precise design of the Braid, all optimised for the particular application.

Please consult Aflex Hose for further advice.

Alternative PTFE Tube Liners

High Pressure Gas (HPG) and Antistatic (AS)

High Pressure Gas (HPG Grade) PTFE Tube Liners (Available to Special Order Only)

For applications where gases are used in the hose at high pressures, or testing procedures above 100 bar (1500 psi) it is necessary to specify an HPG grade PTFE liner tube. HPG grade is also required when high pressures are applied to “penetrating” fluids.

HPG grade tubing is achieved by subjecting the PTFE tube to certain special processes, commonly known as “post sintering”, which increases the resistance of the material to penetration and porosity development by gases in service.

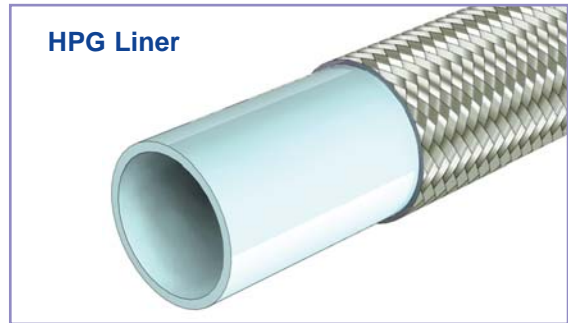

HPG Specification

This specification requires that when compressed air or nitrogen is applied to a sample length at a pressure of 275 Bar (4000 psi) for 1 minute, then the pressure rapidly broken then re-applied for a total of 10 cycles, the the sample must not show signs of excessive diffusion when finally gas tested under water.

Because pure gases do not generate static charges, HPG liners are rarely required to be antistatic, but on such rare occasions, a special “inner layer” AS grade is used as described at the bottom of this page.

Note: All sizes and types of Smoothbore Hose PTFE tube liners can be supplied to HPG quality. In practice, however, HPG hoses are nearly always HW (Heavy Wall) grade, in bore sizes from 6mm (1/4”) up to 10mm (3/8”).

Anti-Static (AS Grade) PTFE Tube Liners (Available to Special Order Only)

Purpose

An AS Grade PTFE tube liner is an essential requirement in applications where there is a risk of an electrostatic charge build-up on the inside surface of the PTFE tube which may then discharge through the tube wall. Media passing through which create such a risk are fluids which have a Conductance of less than 10^{-8} S/m (Siemens per Metre), or 10^4 pS/m such as fuels, solvents, freons, some oils, some WFI (ultra-pure “Water for Injection”) and non-polar organics which are being transferred at a medium to high flow velocity (more than 2 mtrs/sec.)



All twin or multi phase media, and any non-mixing media, such as powder in air, or water droplets in steam, in gases or in oil, also colloidal fluids constitute a particular hazard for static charge generation, and always require grade AS.

Design & Approval

Aflex Hose AS Grade PTFE tube liners are manufactured from FDA 21 CFR 177.1550 approved PTFE, and less than 2.5% of “high purity” Carbon Black material to FDA requirement 21 CFR 178.3297. The carbon is encapsulated by the PTFE, and in normal, non-abrasive applications will not come loose to contaminate any fluid passing through. Leachables and Extractables testing has confirmed that no loose carbon was found.

HPG/AS Grade Liner

The carbon is mixed into the PTFE for the whole wall thickness of the tube, EXCEPT for rare applications where both HPG and AS are required. For such HPG/AS grade tubes, only an inner layer of the wall thickness is AS grade PTFE, with the outer layer in natural PTFE (see drawing).



Plastic or Rubber Hose Covers

ALTERNATIVE PTFE HOSE COVER DESIGN OPTIONS

Purpose

For many applications, it is required that Smoothbore PTFE hose of all sizes, grades and braids should have an outer cover of a flexible plastic, or rubber.

This is usually required to protect the braid, or to colour the hose, or to allow printing on to the hose.

Plastic Covers - available to special order

PVC - flexible PVC covers are the most popular, either transparent, or a wide range of solid or semi-transparent colours.

A particular application is for -3 size single braid, clear PVC covered hose, used as a brake hose for motorbikes, motorsport and special vehicles.

PVC covers are designated as "PVC" followed by the colour if a solid colour is required or "Trans" then the colour if a semi-transparent colour is required. PVC cover will be 0.025" (0.63mm) as standard, alternative cover thickness is available on request.

For example - "-3 HW, SB, PVC Blue" would call for a -3 heavy wall, single braid hose with a solid, blue PVC cover.

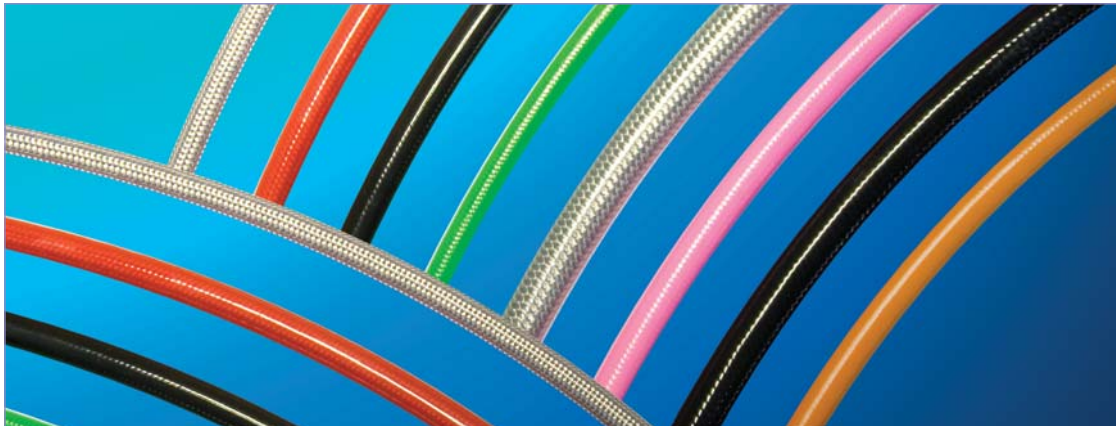

Nylon II (Nyl), Hytrell (Hyt), Sarlink (Sar) and other types of flexible thermoplastics are also widely used.

Text can be continuously printed along the hose length, usually in black.

Rubber Covers - available to Special Order

Aflex Hose also have rubber extrusion facilities, and can continuously extrude rubber covers on to all grades of hose.

EPDM rubber in blue (RC Blue) or black(antistatic) (RC Black), or platinum cured Silicone rubber in transparent (SI) or white (SI White) are available to special order. Other colours and types of rubber may also be available. Consult Aflex Hose for details. Standard thickness of EPDM/Silicone covers are 0.040" (1mm). Other thicknesses are available on request. EPDM covers are only available in sizes from 1/4" (-5).

"PRICKING" of Hose Covers

When covered hose is used in gas applications, it is always necessary to "prick" the cover at intervals, to allow the release of any diffused gas. Rubber covered hose is always pricked, but plastic covered hose is not, so pricking must be specially requested for all gas applications requiring plastic covered hose.

Colour References

If a particular grade of one colour is required, a RAL Number or a colour reference sample is required.

Note: Coloured covers are to special order, and require a Set-Up Charge, so small quantities are usually not economic.

Limitations in Use - The application of a plastic or rubber cover limits the usage conditions of the hose, particularly the operating temperature ranges, as given below.

Flexible PVC from -10°C (+14°F) to +60°C (+140°F)

Nylon II from -40°C (-40°F) to +120°C (+248°F)

EPDM Rubber from -40°C (-40°F) to +140°C (+284°F)

Silicone Rubber from -73°C (-100°F) to +204°C (+400°F)

Smoothbore Hose End Fittings - PTFE Tail and Hydraulic Tail

PTFE TAIL END FITTINGS FOR SW AND HW GRADES

Aflex Hose keep in stock a wide range of “PTFE-tail” design standard end fittings, ferrules and adaptors in both zinc plated carbon steel and 316L stainless steel.

These are specified, with the relevant Aflex Hose Part Number, on Page 11.

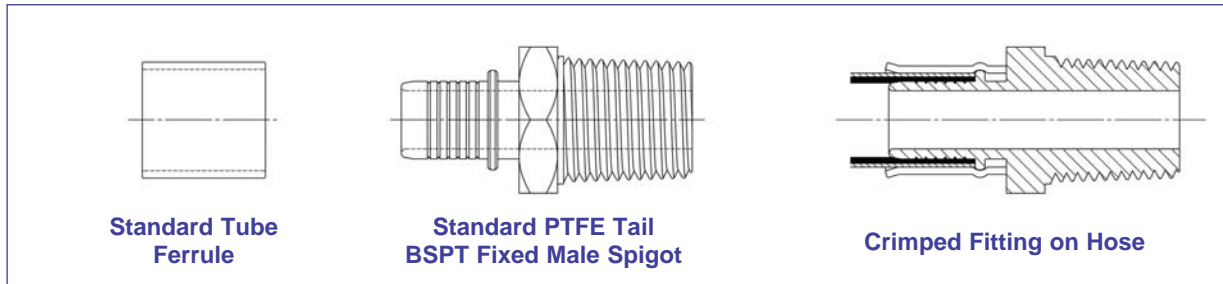

PTFE-Tail End Fittings can only be applied to the Standard Smoothbore, Standard Wall (SW) and Heavy Wall (HW) Hose Grades.

HYDRAULIC-TAIL END FITTINGS FOR MW GRADE

These can only be used with the Standard Smoothbore, Medium Wall (MW) Hose Grade.

Hydraulic Tail end fittings are usually sourced from local Hydraulic Suppliers, but can be supplied by Aflex Hose if required.

Ferrules for MW, SB and MW Hose can be supplied by Aflex Hose, as below.

Ferrule Sizes and Part Numbers

| MW, SB Hose | Zinc Plated Carbon Steel | Stainless Steel |
|-------------|--------------------------|-----------------|
| 3/16 BB -4 | 01-170-03-03-04 | 01-170-03-03-03 |
| 1/4 BB -5 | 01-170-04-04-04 | 01-170-04-04-03 |
| 5/16 BB -6 | 01-170-05-05-04 | - |
| 3/8 BB -8 | 01-170-06-06-04 | 01-170-06-06-03 |
| 1/2 BB -10 | 01-170-08-08-04 | 01-170-08-08-03 |
| 5/8 BB -12 | 01-170-10-10-04 | 01-170-10-10-03 |
| 3/4 BB | 01-170-12-12-04 | 01-170-12-12-03 |
| 1 BB | 01-170-16-16-04 | 01-170-16-16-03 |

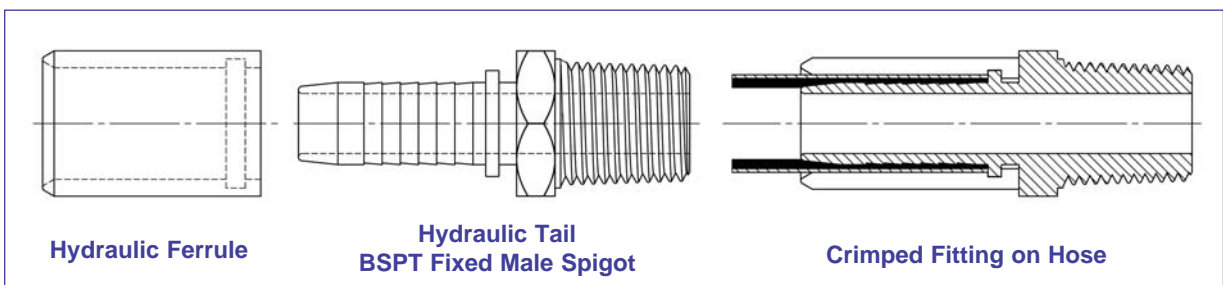

List of PTFE Tail End Fittings for Standard Smoothbore Hose Grades

Fitting Sizes, Types and Part Numbers



| Hose Size and Grade | Fitting Material | Fixed Males | | Fixed Female NPT | Cone Seat Female Union BSPP | Cone Seat Male-to-Male Adaptors | 37° JIC Female Unions | JIC-to-NPT Male/Male Adaptors | Ferrules | |
|---------------------|------------------|----------------------|---------------|------------------|-----------------------------|---------------------------------|-----------------------|-------------------------------|-------------------------------|-------------------------------|
| | | BSPT 06-100- | NPT 06-110- | 33-100- | 07-500- | 18-100- | 07-597- | 18-202- | For SB Hose 01- | For DB Hose 01- |
| -3 HW | SS MS | - 02-02-04 | - | - | 02-02-04 | - | - | - | 120-02-02-01 120-02-02-04 | - |
| 3/16" HW | SS MS | - | - | - | - | - | - | - | 120-03-03-02 120-03-03-04 | - 120-04-04-04 |
| 1/4" SW & HW | SS MS | 04-04-01 04-04-04 | 04-04-01 - | 04-04-01 - | 04-04-01 04-04-04 | 04-04-01 04-04-04 | 07-04-01 - | 07-04-01 - | 120-04-04-02 120-04-04-04 | 125-04-04-02 *125-04-04-04 |
| 3/8" SW & HW | SS MS | 06-06-01 06-06-04 | 06-06-01 - | 06-06-01 - | 06-06-01 06-06-04 | 06-06-01 06-06-04 | 09-06-01 - | 09-06-01 - | 120-06-06-02 120-06-06-04 | 180-06-06-02 170-06-06-04 |
| 1/2" SW & HW | SS MS | 08-08-01 08-08-04 | 08-08-01 - | 08-08-01 - | 08-08-01 08-08-04 | 08-08-01 08-08-04 | 12-08-01 - | 12-08-01 - | 120-08-08-02 120-08-08-04 | 180-08-08-02 150-08-08-04 |
| 3/4" SW & HW | SS MS | 12-12-01 12-12-04 | 12-12-01 - | 12-12-01 - | 12-12-01 12-12-04 | 12-12-01 12-012-04 | 17-12-01 - | 17-12-01 - | 240-12-12-02 120-12-12-04 | 240-12-12-02 180-12-12-04 |
| 1" SW & HW | SS MS | 16-16-01 16-16-04 | 16-16-01 - | 16-16-01 - | 16-16-01 16-16-04 | 16-16-01 16-16-04 | 21-16-01 - | 21-16-01 - | *120-16-16-01 120-16-16-04 | 180-16-16-02 180-16-16-04 |
| 1 1/4" HW | SS MS | 20-20-01 - | 20-20-01 - | - | 20-20-01 - | - | - | - | - | 150-20-20-02 150-20-20-04 |
| 1 1/2" HW | SS MS | 24-24-01 - | 24-24-01 - | - | 24-24-01 - | - | 30-24-01 - | 20-24-01 - | - | 150-24-24-02 150-24-24-04 |
| 2" HW | SS MS | 32-32-01 - | 32-32-01 - | - | 32-32-01 - | - | - | - | - | 150-32-32-02 150-32-32-04 |

* 1" Ferrules for HW, SB hose are 01-150-16-16-02 (and 04).

Example: Part Numbers for a 1/2" NPT Fixed Male in SS is 06-110-08-08-01.

Note: The last 2 digits of the Part Number indicates the material: 01=316 SS, 02 = 304 SS, 04 = Zinc Plated Carbon Steel.

How To Order Smoothbore Hose, Hose End Fittings or Hose Assemblies

SMOOTHBORE HOSE (Supplied loose - without end fittings attached)

The hose[⊗] size and grade requires specification as shown in this brochure.

Either the combination of initials is used to specify the grade:

Example “ ¼” VH1, HPG, AS, RC (Blue)” specifies a ¼” nominal bore hose to the very high pressure grade specification, which has a tube liner which is both High Pressure Gas quality, and Antistatic, and the hose has an outer cover of blue EPDM rubber.

Or the Part Number of the hose as listed in this brochure can be used, together with any additional requirements for Example “Part No 70-310-03-01-02, PVC Trans Blue” specifies -3 Medium Wall Hose, with an HPG quality PTFE Liner tube (-310), and a semi transparent blue PVC cover.

Bulk hose is normally supplied in random production lengths, in loose coils or on wooden reels dependent upon quantity.

Specific lengths, or minimum lengths can be specified, but will require an extra charge.

SMOOTHBORE HOSE CUT TO LENGTH (with non-flared ends)

Aflex Hose are also able to supply Smoothbore Hose in ready-to-assemble pre-cut lengths, with the braid wire at the ends annealed and cut so the cut ends do not flare out. This makes it easier to slide ferrules on to the hose ends during assembly.

This can be applied to all sizes up to 1” bore Smoothbore, Single Braid hose for minimum quantities of 500+ lengths. Minimum cut length 60mm (2^{3/8}”), lengths cut to an accuracy of 1.5mm (1/16”).



⊗ The actual bore size of hose required by customers is sometimes hard to define if the hose was previously purchased from another supplier, especially in the case of “dash” size (e.g. -10) hose size references. In such circumstance Customers are requested to consult the Aflex Hose size specifications, also to state the actual bore size of the hose they require (not the nominal bore size according to another supplier). Alternatively, a short sample of the hose required can be sent to Aflex for examination.

HOSE END FITTINGS (Supplied loose)

The end fittings and ferrules supplied require specification as shown in this brochure. Each end fitting supplied requires a ferrule which fits the type of hose to be used, as listed with Part Numbers on pages 10 & 11.

Either a written description of the size, type and material of the end fitting or ferrule is required, for example: - “3/8” Cone Seat Female Union Fitting in Stainless Steel”.

Or The Part Number of the component, for example: “Part No. 01-120-08-08-02” specifies a 1/2” Stainless Steel Ferrule, suitable for a 1/2” bore single braid hose.

Note: Special Crimp Tools are required for ferrules on a PTFE-Tail Fitting, available from Aflex Hose.

HOSE ASSEMBLIES

The hose size and grade, and the hose end fitting for each end of the hose assembly require specification as stated above. (The ferrules do not require specification).

The overall length of the Hose Assembly is required, between the sealing faces of the end fittings. The length tolerance for Smoothbore hose assemblies is minus 0%, plus 1 1/2% up to 1 metre long, and minus 0%, plus 2 1/2% for over 1 metre long.

HYDROSTATIC PRESSURE TESTING (To 1.5 times the listed maximum working pressure)

Hose supplied loose is not pressure tested, and the assembling Customer is responsible for pressure testing hose assemblies prior to use.

Smoothbore Hose Assemblies supplied by Aflex are all pressure tested for quantities up to 10 off, but only 10% of the quantity are normally pressure tested if more than 10 off are ordered.

Smoothbore Hose: Special Usage Conditions

PTFE HOSE-USE WITH ALKALI METALS, HALOGENS AND HALOGEN CONTAINING CHEMICALS

PTFE hose liners react chemically with Fluorine, Chlorine Trifluoride and molten Alkali Metals.

When PTFE lined hose is used to carry Chlorine or Bromine, either as gasses or fluids, they will diffuse into and through the PTFE liner wall thickness. Trace quantities will then combine with atmospheric moisture to corrode any braid/rubber outer coverings.

Heavily halogenated chemicals, like Hydrogen Fluoride, Hydrogen Chloride, Phosgene (Carbonyl Chloride) Carbon Tetrachloride and other organic chemicals with a high halogen content can also be absorbed and transmitted through the PTFE liner tube.

OTHER “PENETRATING” FLUIDS AND GASES

Sulphur Trioxide, Methyl Methacrylate, Caprolactam and Glacial Acetic Acid are some other chemicals which can be absorbed and transmitted through the PTFE liner tube wall.

Generally, however, as a hydrophobic (non-wetting) material, PTFE is very resistant to the absorption of chemicals. In some cases, PTFE has superior resistance to diffusion, for example to the diffusion of automotive fuels, in comparison with all other plastics and rubbers.

GAS/FLUID CYCLING

There are some applications where the fluid passing through the hose turns into a gas, then back into a fluid, then into a gas etc, in a cyclic sequence.

This is normally associated with changes in temperature and/or pressure. For complex reasons these conditions are extremely damaging to the hose liner, whatever material it is made from.

For example, hoses are sometimes used to pass steam, water, steam etc into rubber moulding presses, in order to heat the mould, then rapidly cool it before reheating in the next cycle. Hoses of all types fail rapidly in such an application and PTFE lined hoses are no exception.

Please contact Aflex Hose for further information if these conditions apply.

CONNECTING ASSEMBLIES FOR USE IN APPLICATIONS

The lengths of hose assemblies and their configuration in use when connected into the application must always be in accordance with the Hose Configuration information at the end of this product literature.

When being connected for use in applications, the end fittings on hose assemblies must be connected to correct mating parts in the correct way, using the correct tools, spanners, clamps, nuts and bolts etc. The connections must be sufficiently tightened to ensure that the joint is leak free but not be over tightened as this can damage the sealing surfaces.

In applications involving the transfer through the hose of expensive or dangerous fluids or gases, the hoses and connections must be pressure tested in situ before being put in to service. This should be done with some harmless media to 1½ times the maximum working pressure of the hose assembly, as stated in the product literature.

If in doubt please contact Aflex Hose for advice.

SPECIAL APPLICATIONS

Aflex Hose PTFE lined hose products are not rated as suitable for use in the following, special applications:

All Radioactive Applications involving high energy radiation, including Gamma radiation (degrades PTFE)

All Medical Implantation Applications.

All Aerospace Applications.

Smoothbore Hose and Quality Assurance, Certification and Approvals, and Hose Testing

BS EN ISO 9001:2008

Aflex products are all manufactured in accordance with BS EN ISO 9001:2008 Quality Management Systems independently assessed and registered by National Quality Assurance Limited (NQA).

TS16949

Aflex Hose Ltd manufactures PTFE flexible hose for the automotive industry in accordance with TS16949 and is assessed and certified by National Quality Assurance Limited (NQA).

FDA

The Materials used to manufacture the natural PTFE Tube liner conforms to FDA 21 CFR 177.1550, and the antistatic PTFE liner conforms to FDA 21 CFR 178.3297.

3-A Sanitary Standards

The PTFE used in the liner is manufactured solely from materials which meet the requirements of the 3-A Sanitary Standards.

Automotive Fuel Hose - SAE J1737

Approved for automotive fuel hose use in accordance with SAE J1737.

CE Marking (Europe only)

Aflex has been assessed by a notified body and found to comply with the Pressure Equipment Directive 97/23/EC (European Community) Conformity Assessment Module D1, approved to CE Mark applicable hose products, accompanied by a Hose Usage Data Sheet, and a Declaration of Conformity.

Attestations of Conformity to ATEX Directive 94/9/EC (Potentially Explosive Atmospheres)

Available for hose assemblies for components used in Gas Zones 1 & 2 and Dust Zones 21 & 22, when applicable.

Material Certification to EN10204

Available for all the hose or hose assembly components.

Certificates of Conformity to BS EN ISO/IEC 17050

Are available for all products.

SAE 100R14 Standard

The MW, Medium Wall Smoothbore range meets or exceeds this standard.

Correct Hose Configuration & Length Calculations - for Bend Radius

Hose Configuration Requirements

Hose Assemblies are usually connected at both ends in service. They may then either remain in a fixed, or static configuration or in a flexing, or dynamic configuration.

Whether static or dynamic, the First Rule concerning the configuration of the hose is that the bend radius of the hose must never be less than the Minimum Bend Radius (MBR) for the hose as listed in the relevant hose brochure.

The most common situation when this is likely to occur is when the hose is flexed at the end fitting, with stress being applied to the hose at an angle to the axis of the end fitting. Typically, this happens either because the length of the hose is too short, or because the weight of the hose plus contents creates a stress at an angle to the end fitting.

The Second Rule, therefore, if possible, is to design the configuration to ensure that any flexing in the hose takes place away from the end fittings.

(Dynamic) Configuration

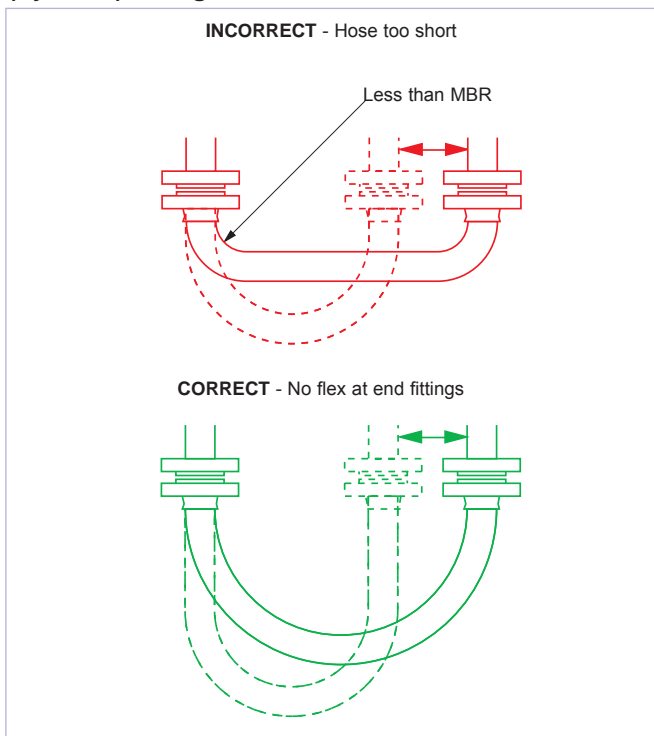

(Static) Configuration

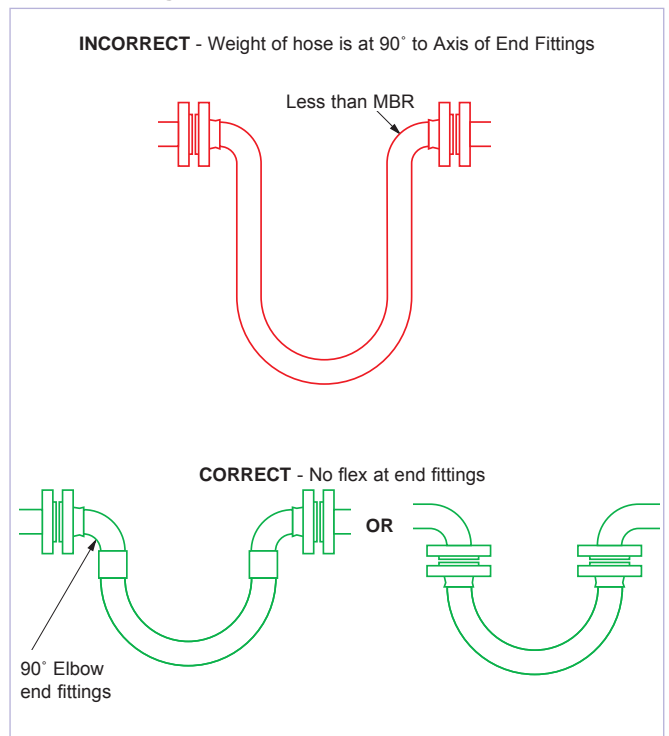

Correct Hose Configuration & Length Calculations - for Abrasion & Torque

The Third Rule is that the hose configuration should always be designed, and supported where necessary, to avoid any possibility of external abrasion.

In some cases, the length, configuration and angle of the hose can be designed to avoid abrasion. In others, static or moving support frames or support wheels are required.

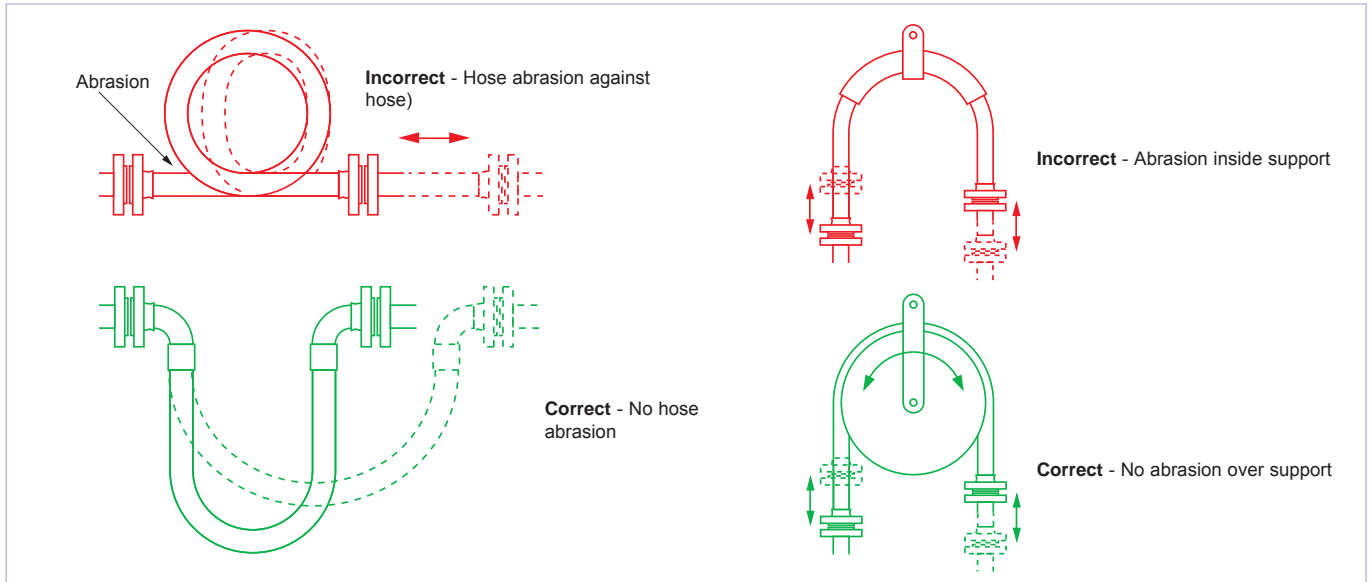

The Fourth Rule is that the hose must not be subjected to torque, either during connection, or as a result of the flexing cycle.

Torque (twist) in the hose can be applied during connection if the hose is accidentally twisted, or if the second end being connected is a screwed connection, and the hose is subjected to torque during final tightening.

In a flexing application, if any flexing cycle of the hose occurs in 3 dimensions instead of 2, then torque will also occur:

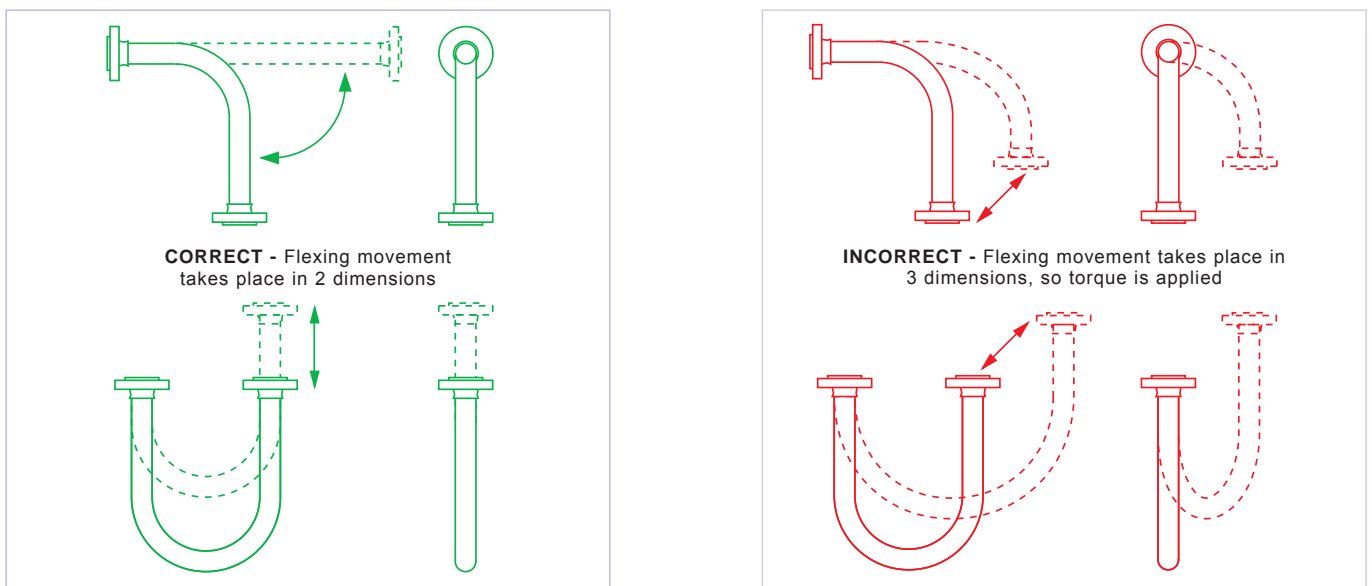

Both Corroflon and Bioflex hose have good resistance to a small level of torque, much better resistance than rubber or SS hose types, but it is still the best practice to take whatever steps are necessary to eliminate torque. If in doubt, consult Aflex Hose.

Hose Configurations & Length Calculations

- for Length Calculation

CALCULATING THE HOSE LENGTH

The formula for calculating the bent section of the hose length around a radius is derived from the basic formula that the circumference of a circle = $2\pi R$, where R = the radius of the circle, and π = a constant, = 3.142.

So, if the hose goes around a 90° bend, which is $\frac{1}{4}$ of a full circumference, and the radius of the bend is R , then the length of the hose around the bend is = $\frac{1}{4} \times 2\pi R$. Or half way round, in a U-shape, = $\frac{1}{2} \times 2\pi R$.

Note :

In calculating the length of a hose assembly, the (non-flexible) length of the end fittings must be added in, also the length of any straight sections of hose, as in the following example:

Example :

To calculate the length for a 2" bore size hose with flange end fittings, to be fitted in a 90° configuration with one leg 400mm long, the other 600mm long.

$$\begin{aligned} \text{Length of Bent Section (yellow)} &= \frac{1}{4} \times 2\pi R (334) \\ &= \frac{1}{4} \times 2 \times 3.142 \times 334 = 525\text{mm} \end{aligned}$$

$$\begin{aligned} \text{Length of top, Straight Section, including the top end fitting length} \\ &= 600 - 334 = 266\text{mm} \end{aligned}$$

$$\text{Length of bottom end fitting} = 66\text{mm}$$

$$\text{Total length of Hose Assembly} = 525 + 266 + 66 = 857\text{mm}$$

Things to consider

- A hose will normally take the longest radius available to it to go around a corner, not the MBR! Also - always remember to include the non-flexible end fitting lengths.
- In dynamic applications, remember to always calculate the lengths for the most extended configuration during the flexing cycle, not the least extended.
- If the configuration is simply too complex for calculation, then obtain a length of flexible tubing of some kind, mark on paper, or a wall, or floor, or both where the connection points will be relative to each other, scaled down if necessary, then manually run the flexible tubing between them with full radii round bends. Measure the extended length, then scale up if necessary to determine the approximate length of the hose.

If in doubt, consult Aflex Hose.

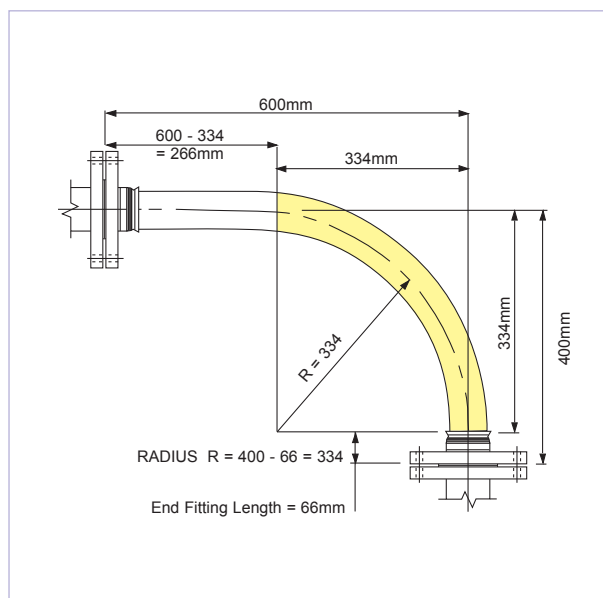
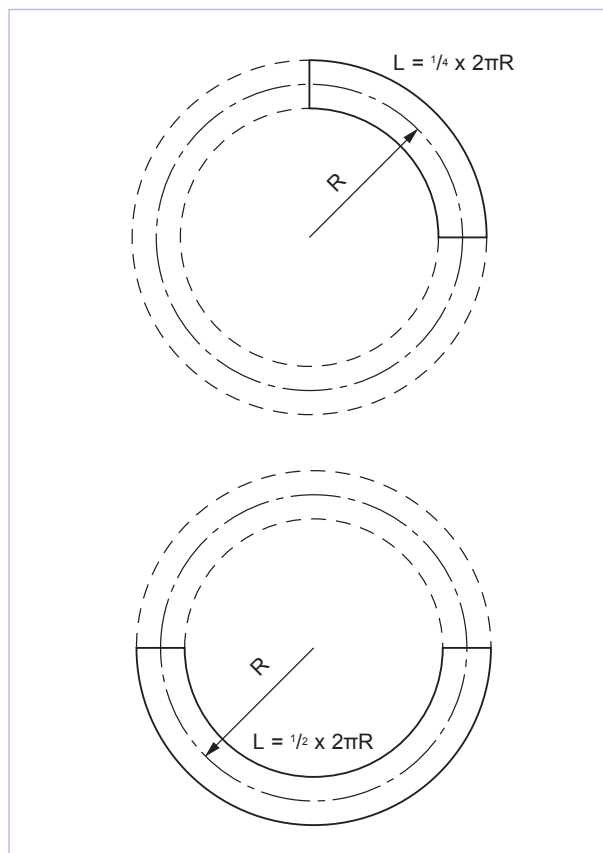

Conditions of Sale

Definitions

- (1) "Aflex Hose" shall mean Aflex Hose Limited
- (2) "Aflex Hose Products" shall mean those products the Customer is purchasing from Aflex Hose.
- (3) "Customer" shall mean the individual or entity that is purchasing Aflex Hose Products hereunder.
- (4) "Full Product Brochure" shall mean the brochure for each specific product available at <http://www.aflex-hose.com/products/>.

General

(5) These Conditions of Sale form the basis of the contract of sale between Aflex Hose and the Customer. In the event of any conflict between the terms and conditions set forth in these Conditions of Sale and any other Customer document, these Conditions of Sale shall govern, unless otherwise agreed to in writing and authorized and signed for by a Director or General Manager of Aflex Hose.

(6) Unless otherwise agreed to in writing, delivery will be at cost from Aflex Hose's facilities Brighouse, West Yorkshire, England. Title and all risks of loss or damage pass to the Customer upon delivery to the Customer or third party carrier. Delivery dates specified by Aflex Hose are only Aflex Hose's best estimates and Aflex Hose's only responsibility will be to use reasonable commercial efforts to meet all specified delivery dates.

Customer Responsibilities and Obligations

(7) It is the Customer's strict responsibility to review all of the usage conditions and usage limitations given for the Aflex Hose Products which are intended for use in a particular application, to ensure that the application conditions are in compliance with those usage limitations. The usage conditions and limitations are referred to in these Conditions of Sale, and are further specified in the relevant Full Product Brochure. The Customer shall consult the latest, up to date hose product information and Full Product Brochure at the time of ordering, which are only available and downloadable from the Aflex Hose website at <http://www.aflex-hose.com/products/>, or on request from Aflex Hose. The Customer here represents and warrants that it has read and understands the applicable Full Product Brochure and the usage conditions and the usage limitations set forth therein, and has ensured their compliance with the application conditions.

(8) If the Customer sells or assigns any Aflex Hose Products to any other person or entity, the Customer shall ensure that the final end user of the Aflex Hose Products is supplied with these Conditions of Sale, the applicable Full Product Brochures, the Aflex Hose website address, together with notification of the requirement to review the usage conditions and limitations. The Customer shall include the terms and conditions set forth herein in its Conditions of Sale to any third party. The Customer hereby agrees and acknowledges that Aflex Hose shall have no liability whatsoever for claims arising in whole or in part out of the Customer selling or assigning the Aflex Hose Products to a third party that does not use the Aflex Hose Products in accordance with Aflex Hose's usage requirements and limitations ("Non-Conforming Use Claims"). The Customer shall indemnify and hold harmless Aflex Hose, its officers, directors, employees, affiliates and representatives for any and all claims, damages, penalties and losses arising out of or related to Non-Conforming Use Claims.

(9) The Customer agrees and acknowledges that for any intended hose application in which special conditions apply which are not defined, or not defined sufficiently in the Product Brochure, the Customer shall write to Aflex Hose requesting written advice relating to any usage limitations resulting from special conditions. The Customer shall ensure the design suitability and safety of the Aflex Hose Products in their intended applications, giving particular consideration to any special condition relating to, but not restricted to the chemical and electrostatic compatibility of the fluids or gases passing through, the possibility of diffusion of fluid or gases through the PTFE hose lining, the possibility of external corrosive conditions, the types and likelihood of excessive mechanical abuse, such as abrasion (internal or external), crushing, excessive flexing or vibrations, etc. and any excessive temperature and/or pressure "pulsing" conditions, or any other condition which may cause premature hose failure. The Customer shall consider, and take account of the degree of risk involved in any hose failure, including the provision of adequate protection in the event of

any risk to any persons. In applications where any type of hose failure would lead to financial losses if the hose is not replaced immediately, the Customer agrees and acknowledges that it shall be the Customer's responsibility to order and hold in stock spare hose(s) accordingly. The Customer shall advise Aflex Hose in writing at the time of placing the enquiry and on any purchase order if there are any special requirements for the hose, including special cleaning, or drying, or extra testing requirements which are in addition to normal industrial standards. The Customer agrees and acknowledges that Aflex Hose, its officers, directors, employees, affiliates and representatives shall not be held liable for any claims or obligations arising out of the Customer's failure to fulfill any or all of its responsibilities set forth in this Section 9.

(10) If the Customer has any doubts concerning these or any other usage conditions and limitation or safety parameters, the Customer shall consult Aflex Hose at the number and address in the Notice Provisions below and request a written response to any queries.

Hose Service Life; 24 Month Warranty

(11) It is not possible to guarantee a minimum service life for any of the Aflex Hose Products which can be applicable for every type of application. As such, Customer acknowledges that, except as provided below in Sections 12, 13 and 14 Aflex Hose is not guaranteeing a minimum service life of any of the Aflex Hose Products.

(12) Service life predictions or guarantees can only be given in cases where all the relevant information concerning the application is given in writing to Aflex Hose, and Aflex Hose subsequently replies in writing with the service life prediction prior to the order being placed.

(13) If such a written undertaking is not sought and given, Aflex Hose shall not be held liable for any Aflex Hose Product failure which the Customer considers to be premature, excepting failures which are due to faulty materials or manufacturing defects which occur within 24 months or 12 months, as applicable, of supply as provided in Section 14 below.

(14) Aflex Hose warrants its Aflex Hose Products to be free from faulty materials or manufacturing defects from the date of the delivery, for 24 months; provided, however, that all Hose Assemblies which are "ETH" (Electrical Trace Heated) Grade are only warranted for 12 months.

(15) AFLEX HOSE MAKES NO WARRANTY OF ANY KIND WHATSOEVER, EXPRESS OR IMPLIED OTHER THAN AS SPECIFICALLY STATED HEREIN, AND THERE ARE NO WARRANTIES OF MERCHANTABILITY AND/OR FITNESS FOR A PARTICULAR PURPOSE WHICH EXCEED THE OBLIGATIONS AND WARRANTIES SPECIFICALLY STATED HEREIN.

Product Failure

(16) In the event of a product failure during the applicable warranty period set forth in Section 14, the Customer shall provide Aflex Hose with written notification within forty-eight (48) hours of discovering the fault. Aflex Hose requires that the Aflex Hose Products not be cut up or tampered with, but should be decontaminated and returned to Aflex Hose, plus a decontamination certificate, for examination and analysis of the fault. The Customer should also provide full details in writing of the application conditions under which the hose failed, including Pressure, Vacuum, Temperature, Flexing and any cycling of any of these, also the fluids, gases and any cleaning products passed through the hose, and the total time that the hose has been in service also the original order number and the Serial Number for the hose. The Customer may send its own witness to the examination if required. Aflex Hose will provide a Non-Conformance Report to the Customer. The Customer shall bear the cost of returning the Aflex Hose Products that have failed; provided, however, as set forth in Section 17 below, Aflex Hose shall reimburse the Customer for any shipping costs if it is determined that the failure is covered by the warranty set forth in Section 14.

Conditions of Sale Continued

(17) If Aflex Hose determines that the faulty materials or a manufacturing defect in the hose is responsible for the hose failure, Aflex Hose's maximum liability shall be the invoice value of the failed hose itself, or the invoice value of the whole customer order as determined by Aflex Hose in its sole discretion, along with any reasonable costs for removal and replacement of the hose, and costs for packing and despatching the failed hose back to Aflex Hose.

Untested Hose for Self Assembly by Customers

(18) Aflex Hose sometimes supplies "loose" hose, without end fittings attached to a Self Assembly Customer, who will then cut the hose to length and attach end fittings to make up Hose Assemblies for their own use, or for sale to their own customers.

(19) Unless the Customer requests, and Aflex Hose confirms that the 'loose' hose is pressure tested before supply, such testing is not normally applied by Aflex Hose, because this testing requirement is otherwise satisfied by the Self Assembly Customer during his own testing of the finished Hose Assemblies made up using the "loose" hose. Self Assembly Customers agree and acknowledge that they are solely responsible for carrying out hydrostatic pressure testing of 100% of such assemblies to 1½ times the Maximum Working Pressure (MWP) of the hose assembly as specified in the relevant Full Product Brochure before supply for end use, to validate both the hose and the end fitting attachment.

(20) When pressure testing braided hoses with a plastic or rubber outer cover, the cover will mask any signs of leakage for a time. The Customer agrees and acknowledges that after the hydrostatic pressure test, it is required to test each covered hose assembly with an internal helium gas pressure of 30 Bar (450 psi) for hose sizes up to 1" and 15 Bar (225 psi) for hose sizes above 1", with the hose assembly immersed in water to enable leak detection by gas bubbles, for a minimum test period of 5 minutes.

(21) The "Self Assembly" Customer agrees and acknowledges that it shall determine and approve the Design Suitability of the hose assemblies for their intended use before supply and that, except as set forth in Section 22, it shall indemnify and hold Aflex Hose harmless from any Claims and Losses arising from Design Suitability for a Self Assembly Customer. This includes proceeding in accordance with Section (7) and Section (8) above.

(22) Aflex Hose's liability is limited to Aflex Hose Products which are assembled by approved Self Assembly Customers if all the hose and fitting components were supplied by Aflex Hose or approved for use by Aflex Hose in writing, and they were assembled and tested in accordance with Aflex Hose's current Manufacturing and Testing Instructions, available to approved Self Assemblers in an I-Bay on the Aflex Hose website.

Untested Hose Assemblies

(23) Aflex Hose is sometimes requested by Customers to attach non-standard end fittings to hose assemblies which they, supply, and in some cases it is not possible to connect these fittings to the Aflex Hose pressure test system. In such cases a "concession not to test" is obtained from the Customer, and a label is attached to the hose assembly, warning that it requires pressure testing before use. The Customer agrees and acknowledges that Aflex Hose shall have no liability whatsoever if the Customer does not comply with the warning that requires pressure testing before use.

Force Majeure

(24) Aflex Hose shall not be liable for any delay in delivery, failure to deliver or default in performing in accordance with any Customer's order if the delay or default is due to: (a) fires, floods, strikes, or other labor disputes, accidents to Aflex Hose's production facilities, acts of sabotage, riots, natural disasters, difficulties procuring materials, shortages of raw materials, interference by civil or military authorities, whether legal or de facto, governmental restrictions, including but not limited to failure to obtain export licenses, delays in transportation or lack of transportation facilities, restrictions imposed by federal, state or other governmental legislation or, rules or regulations thereof, including a force majeure event occurring in respect to one of Aflex Hose's suppliers; or (b) any other cause beyond Aflex Hose's control.

Governing Law; Jurisdiction

(25) These Conditions of Sale and all rights, duties and obligations

hereunder, including any and all other Customer agreements and orders shall be governed by and subject to English Law.

(26) The Customer acknowledges and agrees that any disputes arising out of or related in any way to this Agreement, including a breach of this Agreement, shall be brought exclusively in the courts of England, United Kingdom. Furthermore, Customer knowingly, voluntarily and irrevocably (a) consents to the exclusive jurisdiction of these courts, (b) waives any immunity or objection, including any objection to personal jurisdiction or the laying of venue or based on the grounds of forum non conveniens, which it may have from or to the bringing of the dispute in such jurisdiction, (c) waives any personal service of any summons, complaint or other process that may be made by any other means permitted by England, United Kingdom, (d) waives any right to trial by jury, (e) agrees that any such dispute will be decided by court trial without a jury, (f) understands that it is giving up valuable legal rights under this Section 26, including the right to trial by jury, and that it voluntarily and knowingly waives those rights.

Limitations of Liability

(27) Aflex Hose Products have not been designed or tested for use in aerospace, medical implantation or radioactive applications, and such use is therefore strictly prohibited unless written approval from Aflex Hose has been given. Customer agrees and acknowledges that it is aware of the limitations set forth in this Section 26 and hereby agrees that Aflex Hose shall not have any liability whatsoever in the event Customer uses Aflex Hose Products for aerospace, medical implantation or radioactive applications. Customer agrees to indemnify Aflex Hose, its officers, directors, employees, affiliates and representatives for any and all Claims and Losses arising out of Customer's use of the Aflex Hose Products for aerospace, medical implantation or radioactive applications.

(28) Aflex Hose will not accept liability for any failures of the Aflex Hose Products which are caused by Customers failing to perform their Responsibilities as specified in these Conditions of Sale.

(29) NOTWITHSTANDING ANYTHING TO THE CONTRARY HEREIN, IN NO EVENT SHALL AFLEX HOSE BE LIABLE FOR ANY SPECIAL, INDIRECT, INCIDENTAL, CONSEQUENTIAL, EXEMPLARY, OR PUNITIVE DAMAGES, LOSS OF PROFITS OR REVENUE, LOSS OF PROCESS PRODUCTS, DAMAGE TO EQUIPMENT, DOWNTIME COSTS, OR LOSS OF USE EVEN IF INFORMED OF THE POSSIBILITY OF SUCH DAMAGES. TO THE EXTENT PERMITTED BY APPLICABLE LAW, THESE EXCLUSIONS AND LIMITATIONS WILL APPLY REGARDLESS OF WHETHER LIABILITY ARISES FROM FAILURE OF THE PRODUCT(S), BREACH OF CONTRACT, FAILURE TO DELIVER ON TIME, WARRANTY, TORT (INCLUDING, BUT NOT LIMITED TO, NEGLIGENCE), BY OPERATION OF LAW, OR OTHERWISE.

Completion of Bulk Hose Orders

(30) Due to the nature of the production of PTFE hose, Aflex Hose reserves the right to call an order complete in the following situations. If a product is a standard Aflex product (as listed in Aflex product brochures) a figure of +10% of original order quantity can be supplied. If the product is a non-standard product and outside the Aflex standard product range the figure of +/- 10% of the original order quantity can be supplied. Goods supplied within these parameters would render the order complete.

Notice Provisions

(31) Any written notice required to be provided to Aflex Hose shall be sent to the following address: Aflex Hose Limited, Spring Bank Industrial Estate, Watson Mill Lane, Sowerby Bridge, Halifax, West Yorkshire, HX6 3BW.

Exclusion of CISG

(32) The United Nations Convention on Contracts for the International Sale of Goods shall not apply to these Conditions of Sale and any and all other Customer documents.



UK SB/13.07.15 Rev 31

UK

Spring Bank Industrial Estate
 Watson Mill Lane
 Sowerby Bridge
 Halifax
 West Yorkshire, HX6 3BW
 Tel: +44 (0) 1422 317200
 Fax: +44 (0) 1422 836000

USA

6111 Kellers Church Road
 Unit B
 Pipersville,
 Pa 18947
 Tel: 215 - 766 - 1455
 Fax: 215 - 766 - 1688

www.aflex-hose.com

